

DUWELL

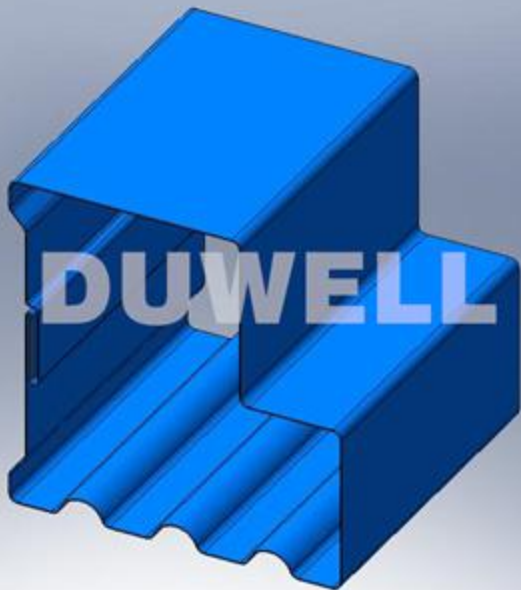

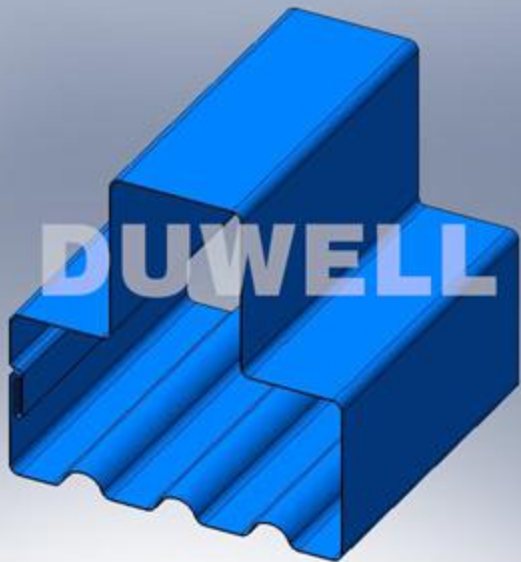

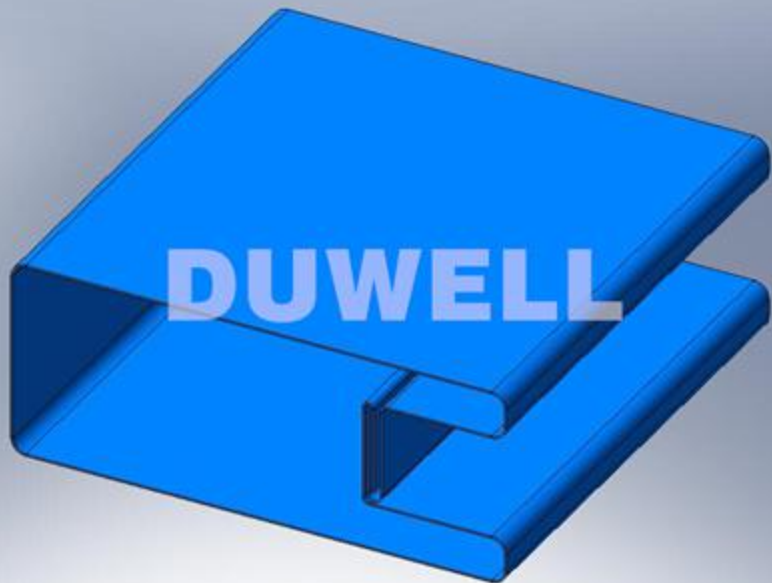

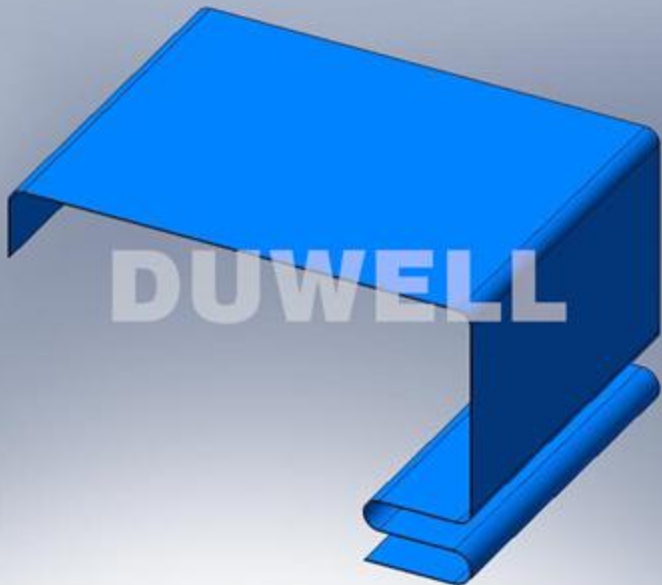

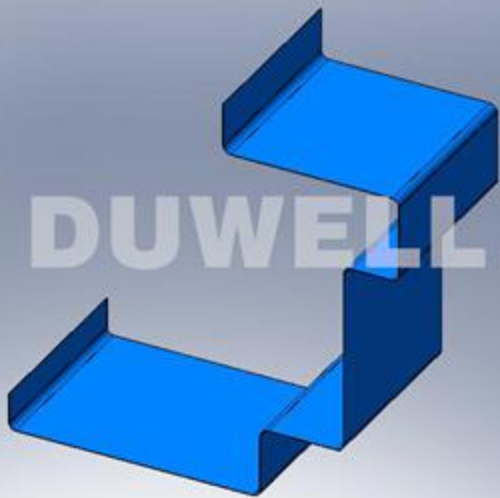

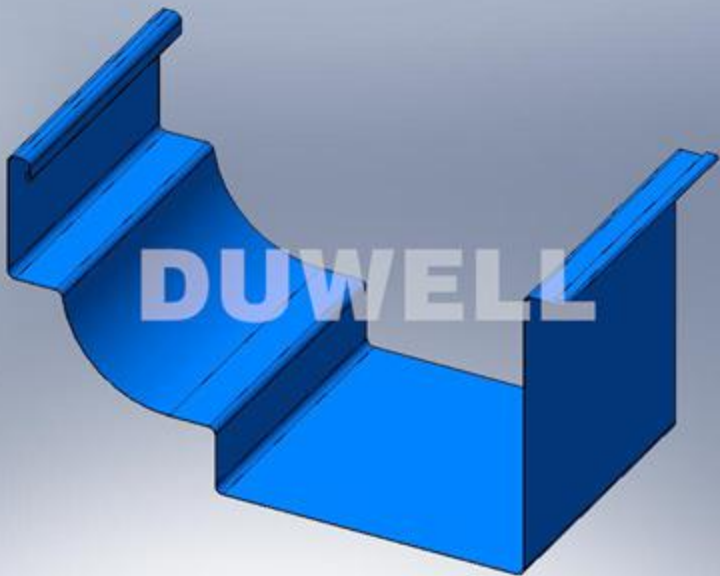



DUWELL

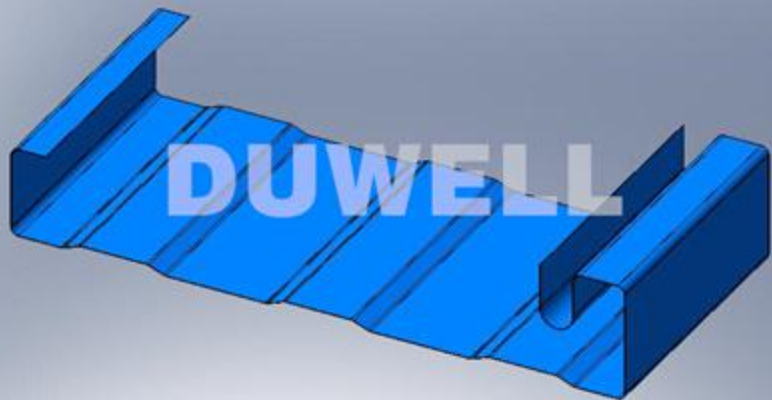

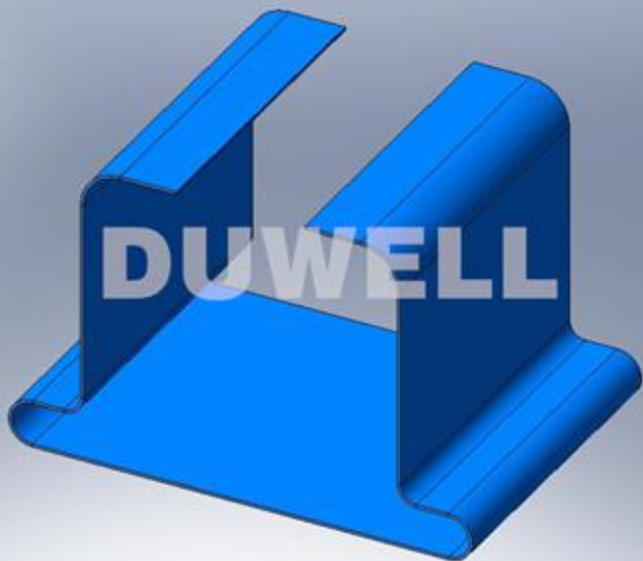

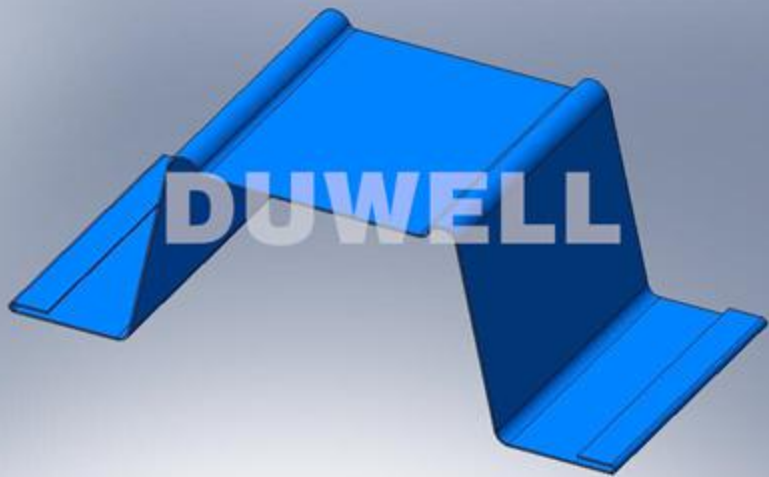

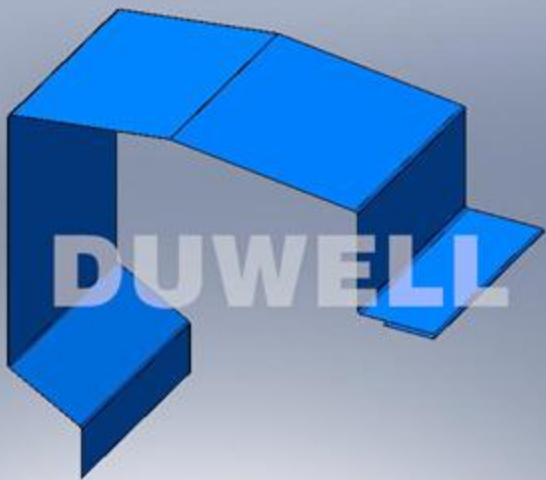

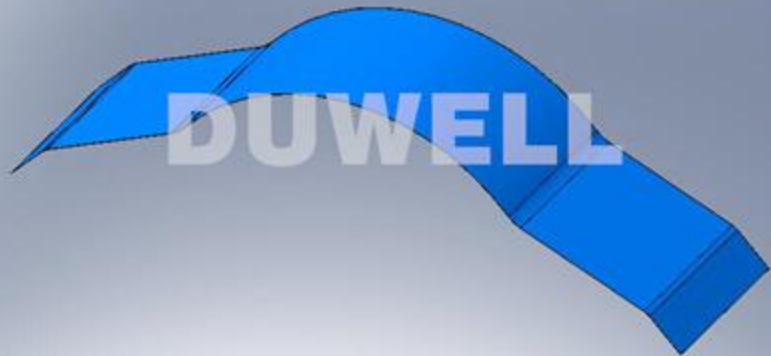

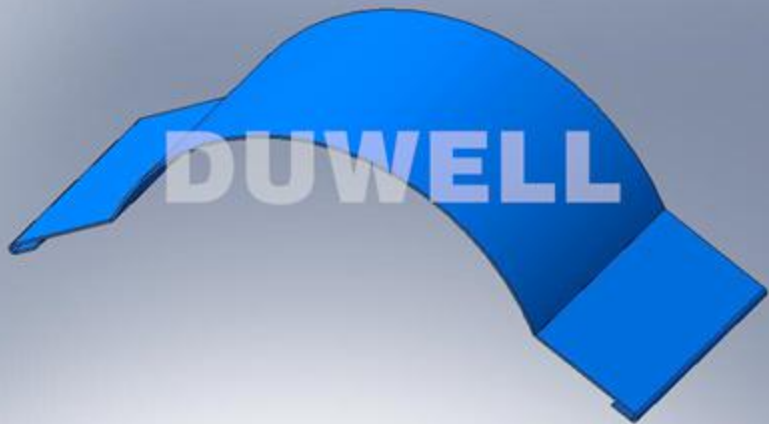







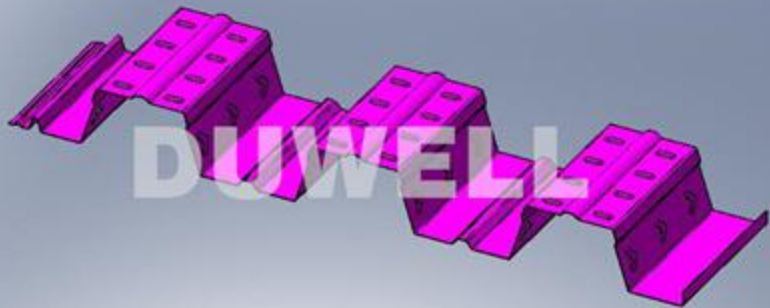

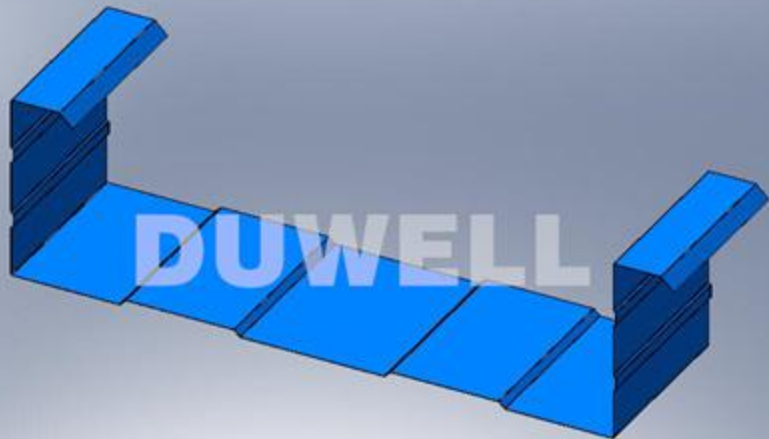

A 3D rendered image of a blue L-shaped extrusion profile, oriented diagonally. The profile has a flat top surface and a vertical side wall. The word "DUJWELL" is overlaid in white, bold, sans-serif capital letters across the center of the image.

DUJWELL

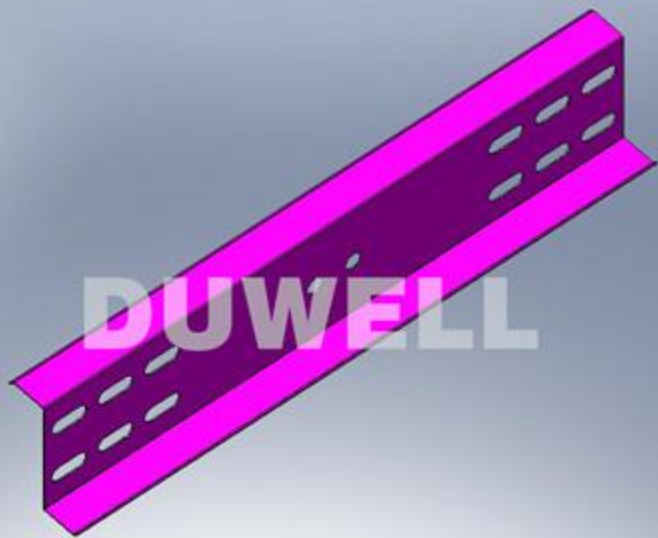

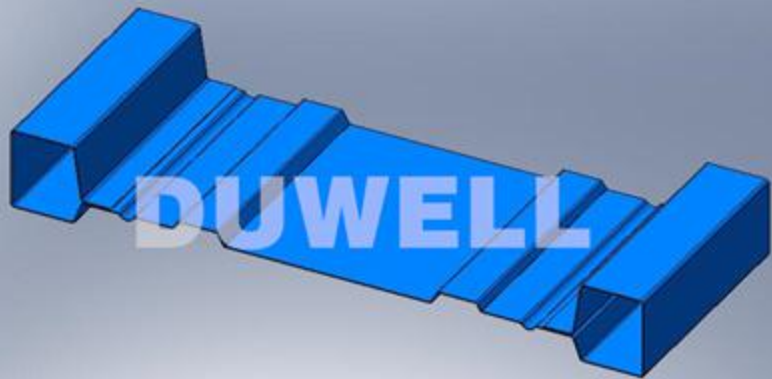

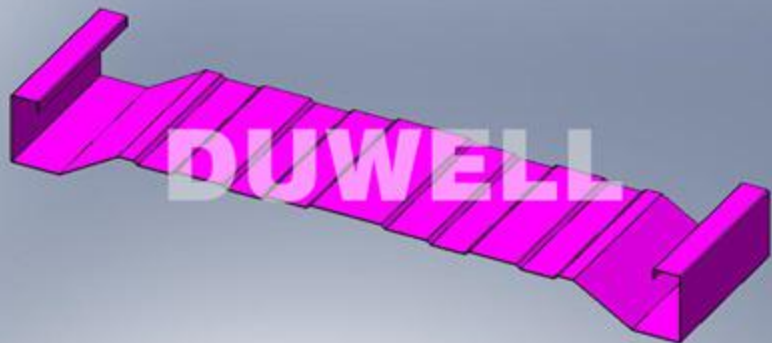



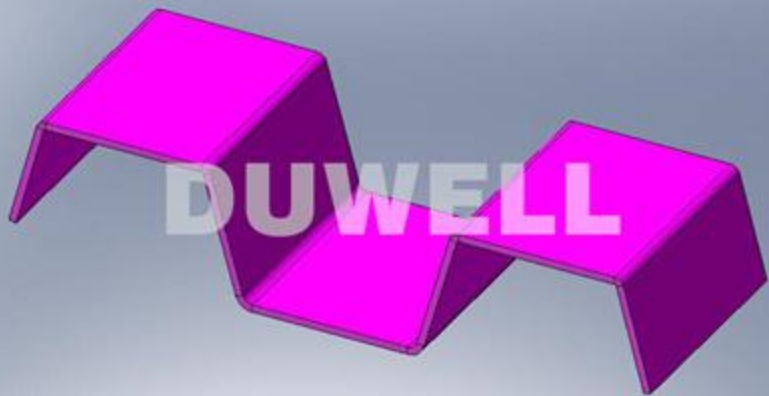

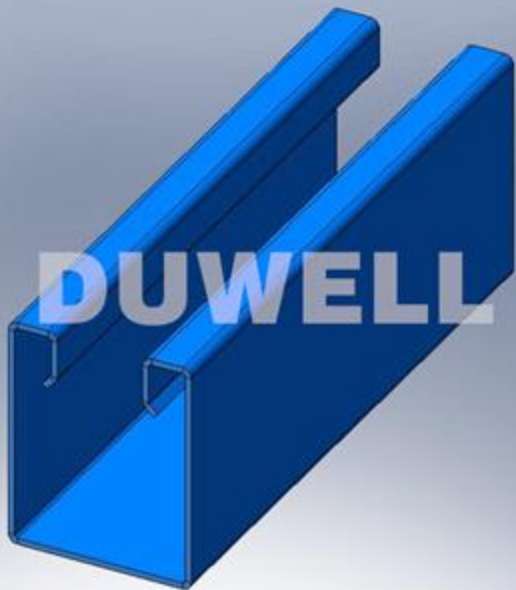

A 3D rendering of a rolled-up pink ribbon. The ribbon is unrolled in the center, forming a wide, flat band. The word "DUWELL" is printed in a bold, white, sans-serif font across the middle of this band. The ends of the ribbon are rolled up into thick, cylindrical shapes on either side. The entire object is set against a light blue background with a subtle gradient.

DUWELL

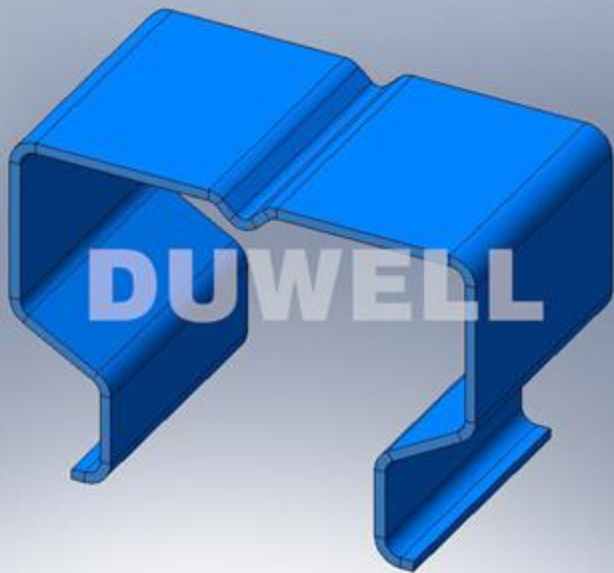

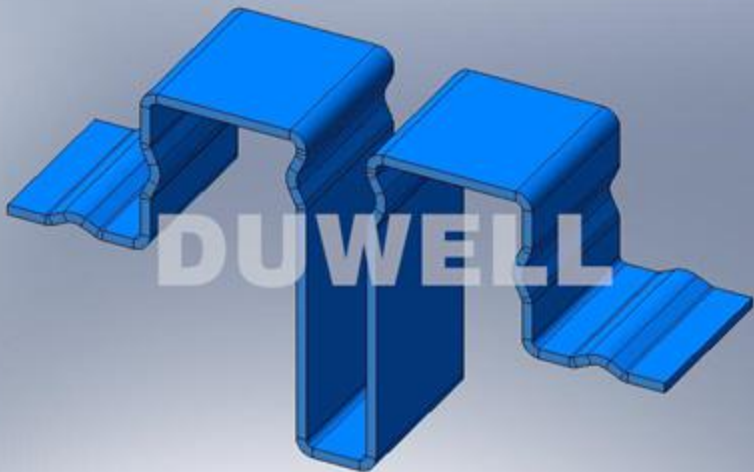

DUWELL

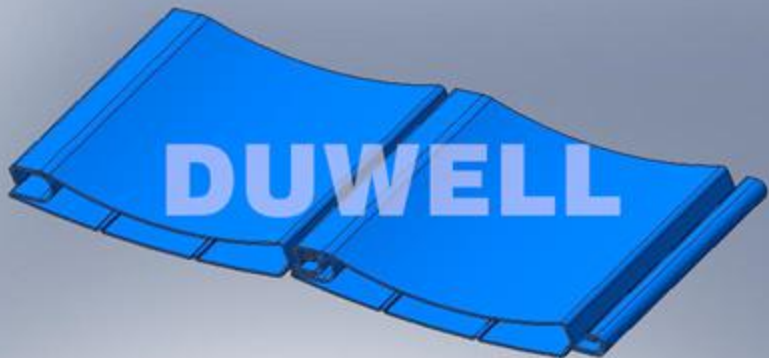

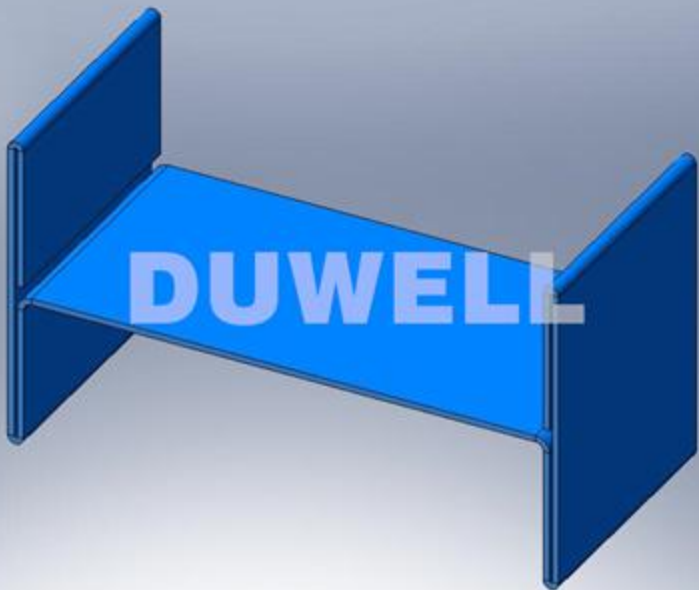

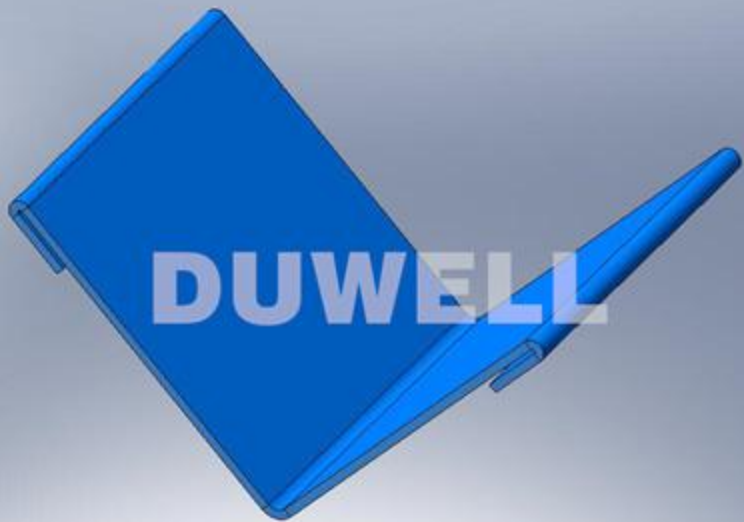

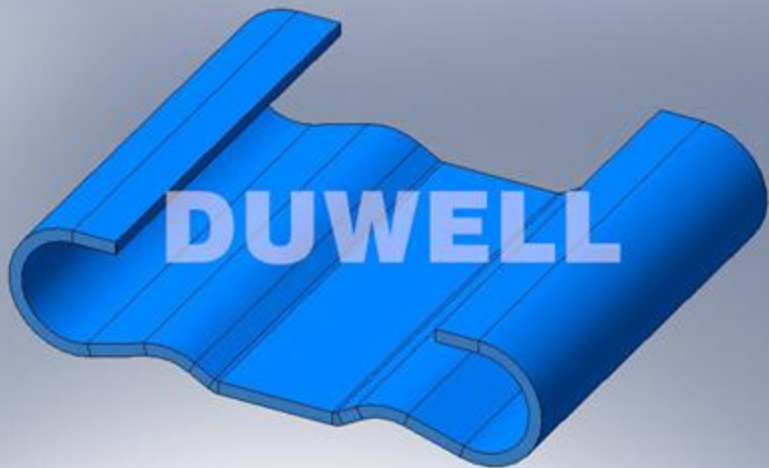

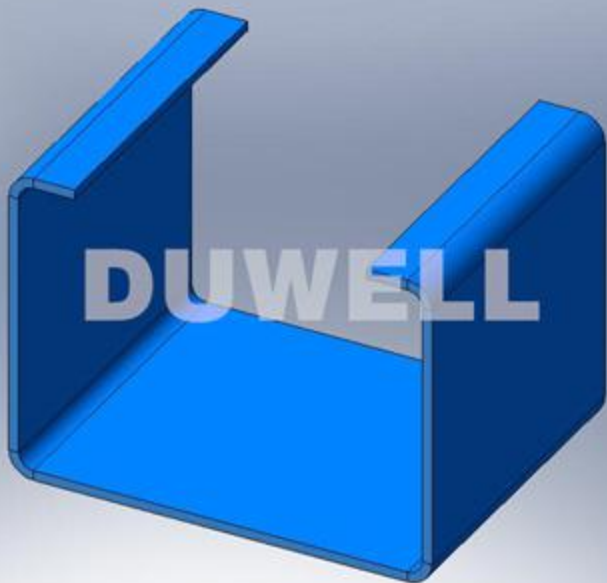

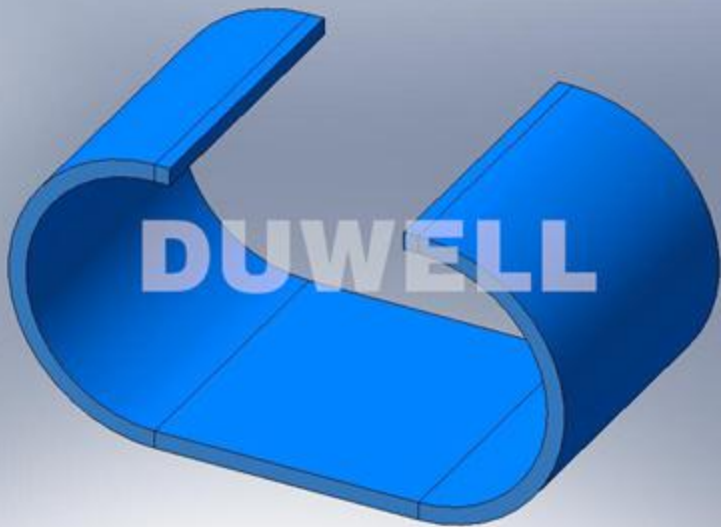



DUWELL

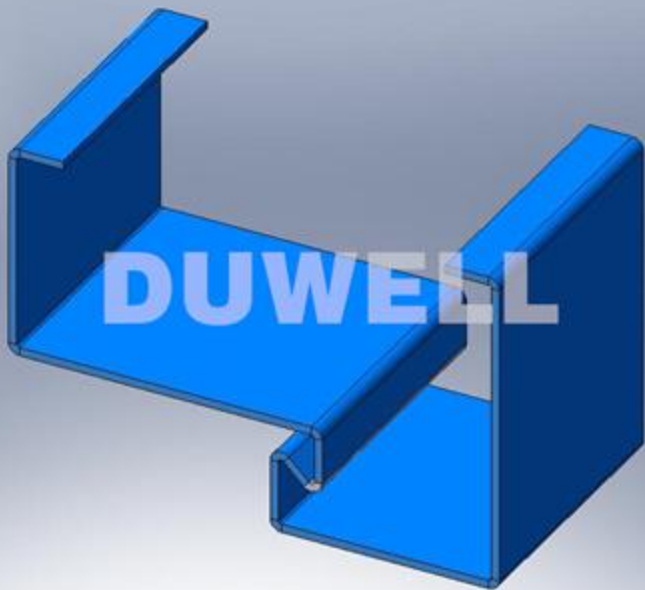

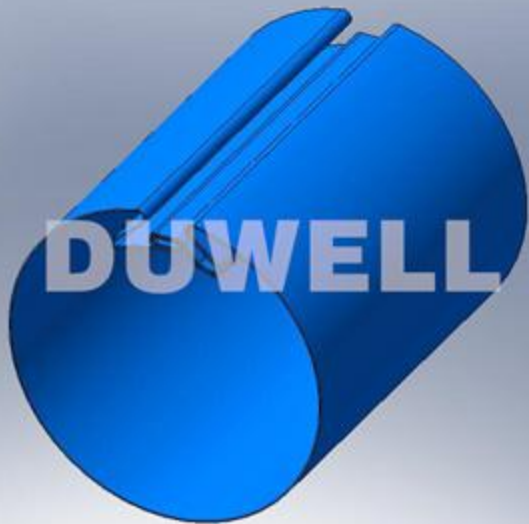



DUWELL

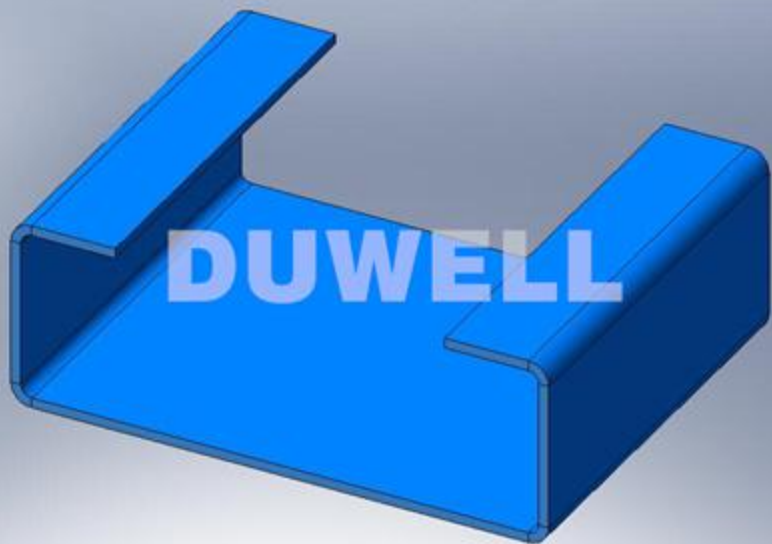

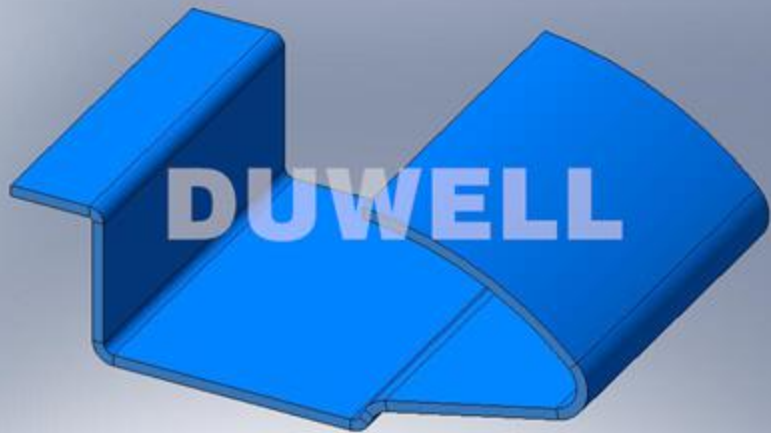

DUWELL

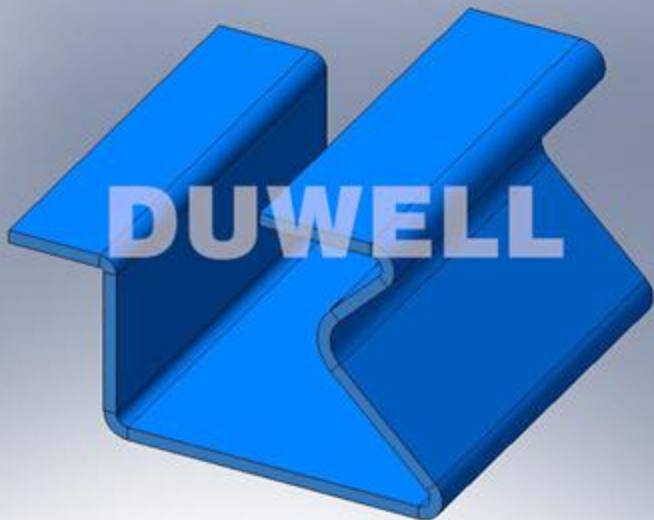

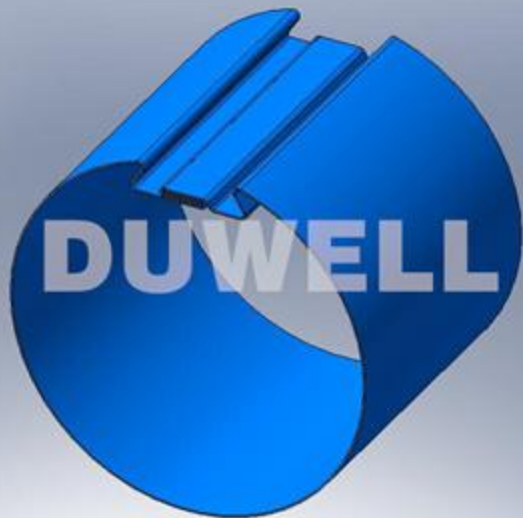

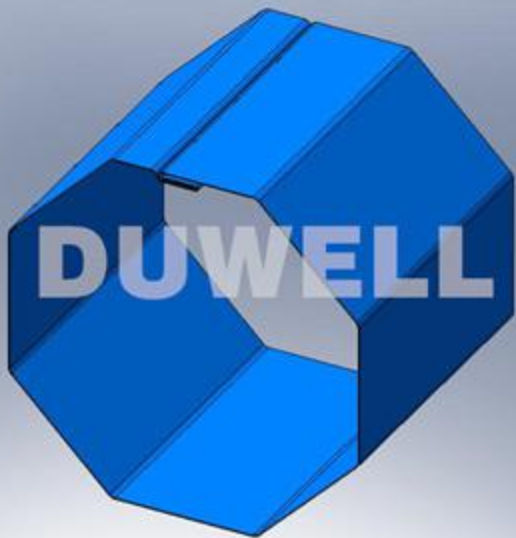



DUWELL

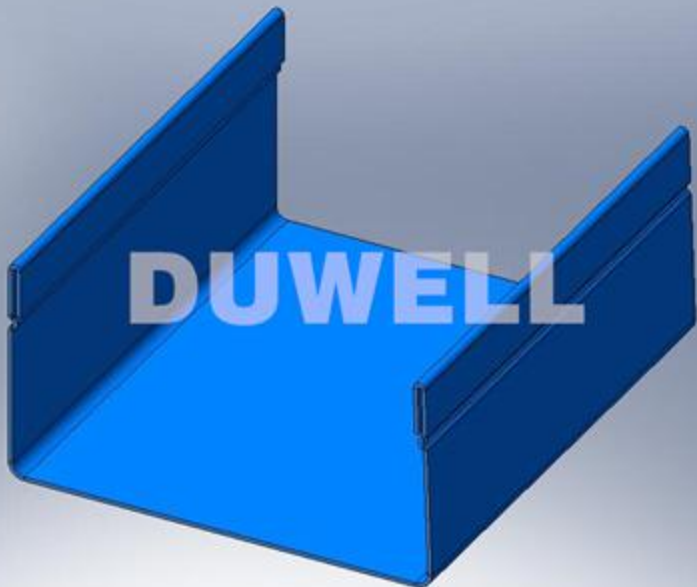

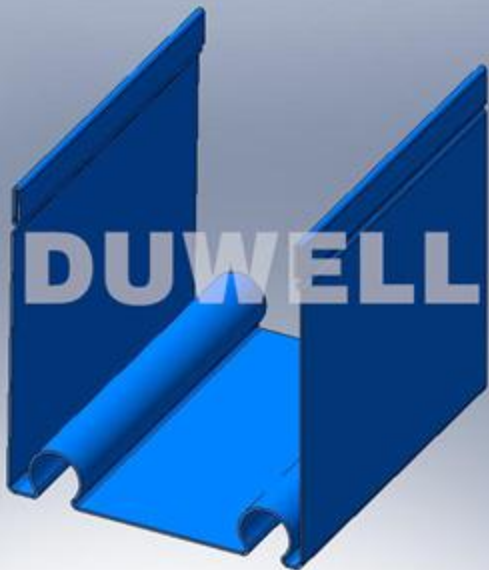

A blue, curved banner with the word DUWELL in white capital letters. The banner is slightly curved and has a 3D effect with shadows on the bottom edge. The background is a light gray gradient.

DUWELL



DUJWELL

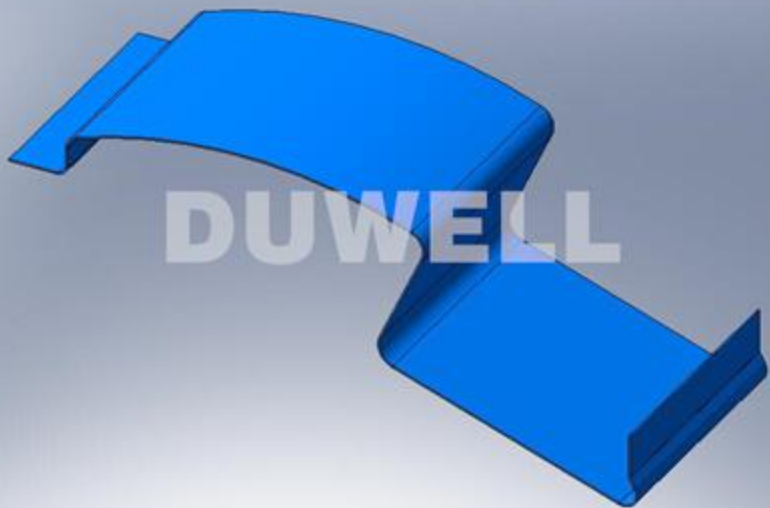

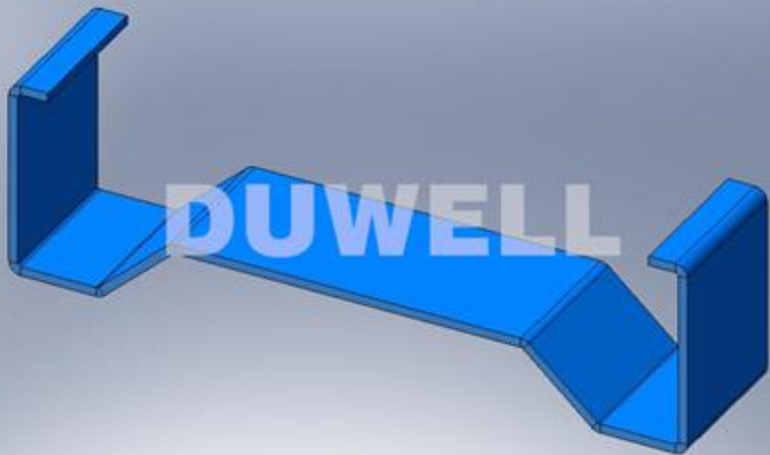

A 3D rendered blue L-shaped object, possibly a corner bracket or a piece of machinery. The object is composed of two perpendicular rectangular sections joined at a corner. The word "DUWELL" is overlaid in the center of the object in a bold, white, sans-serif font. The background is a light blue gradient.

DUWELL

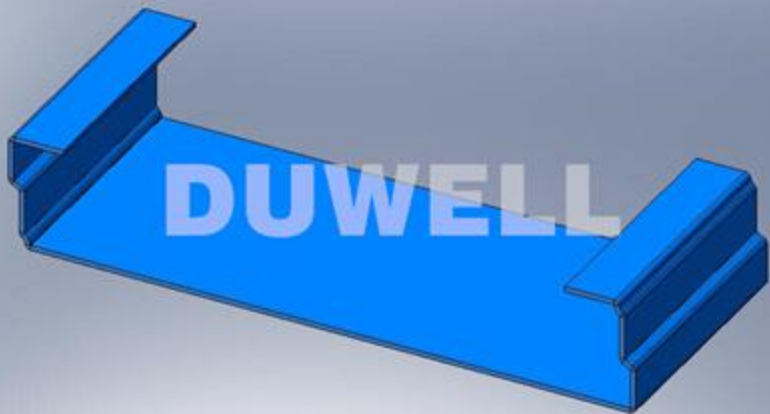



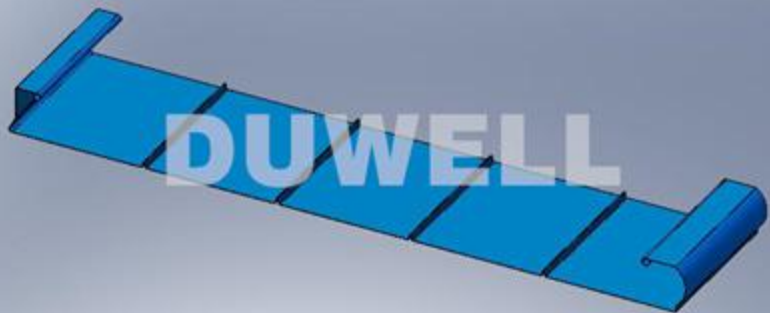

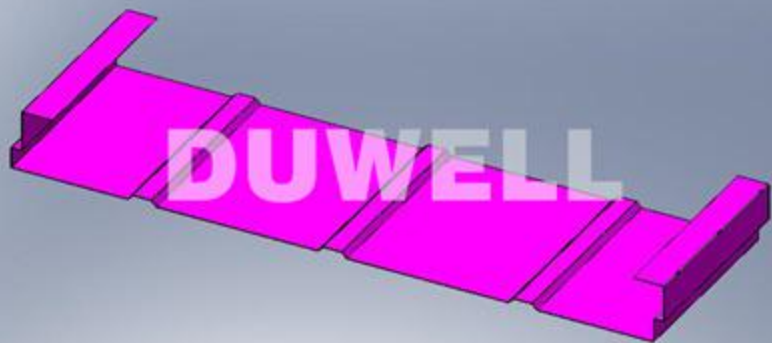

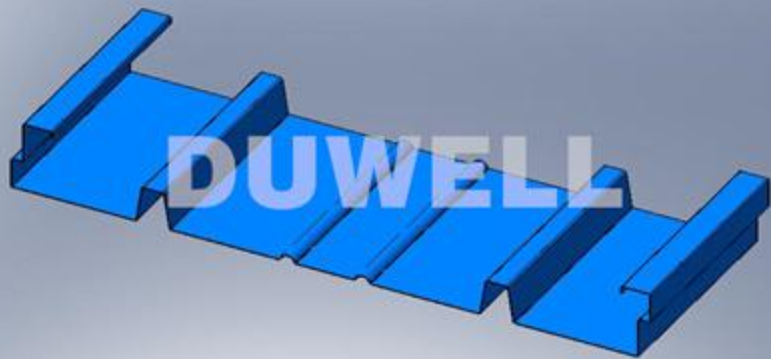

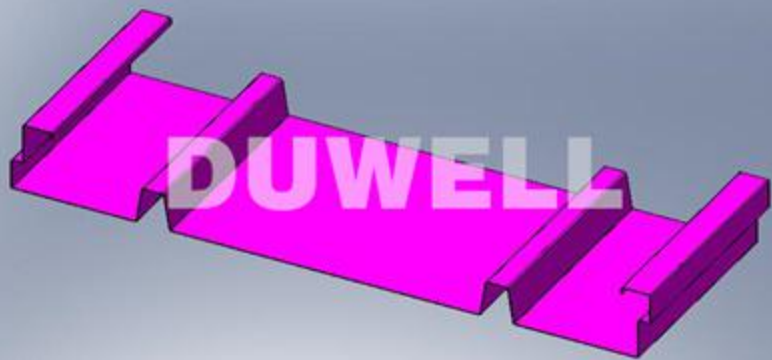







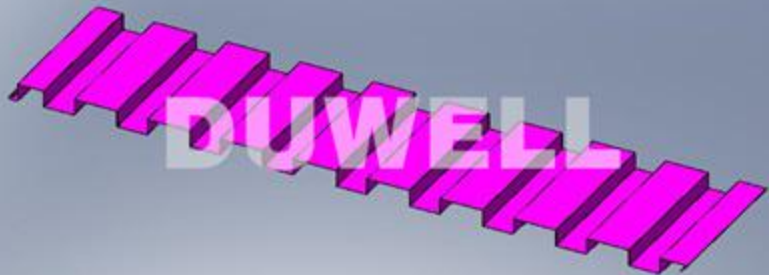





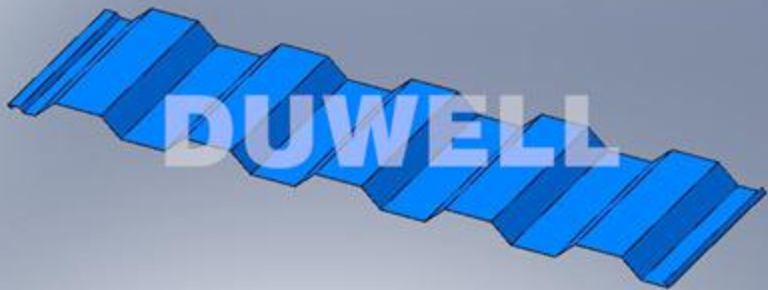

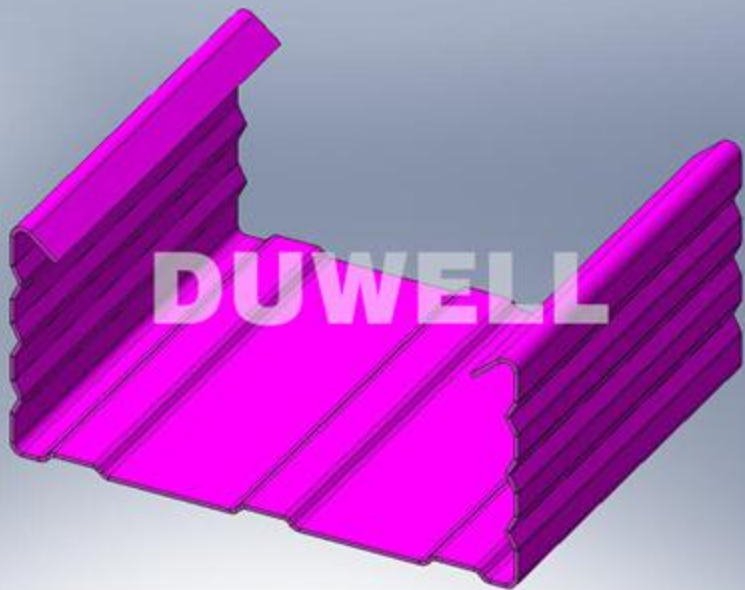

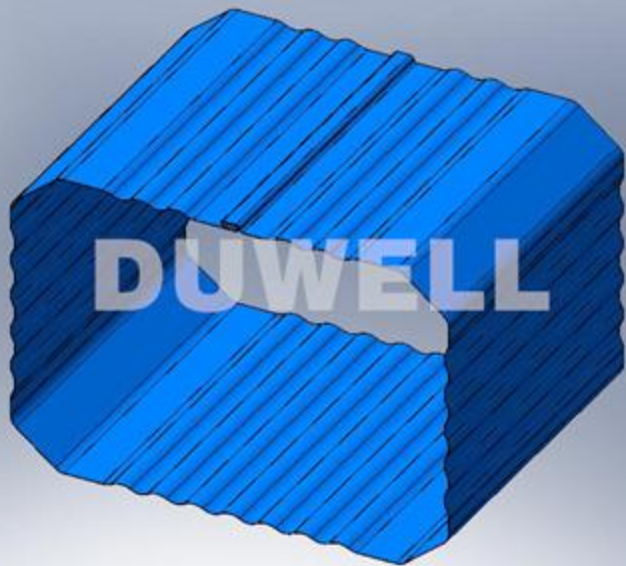

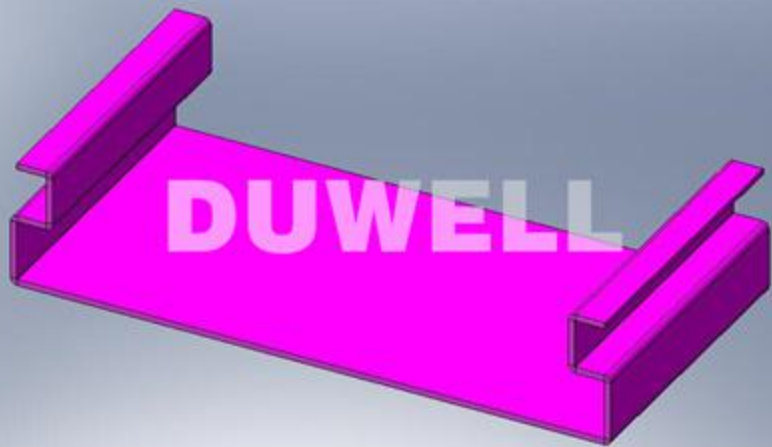

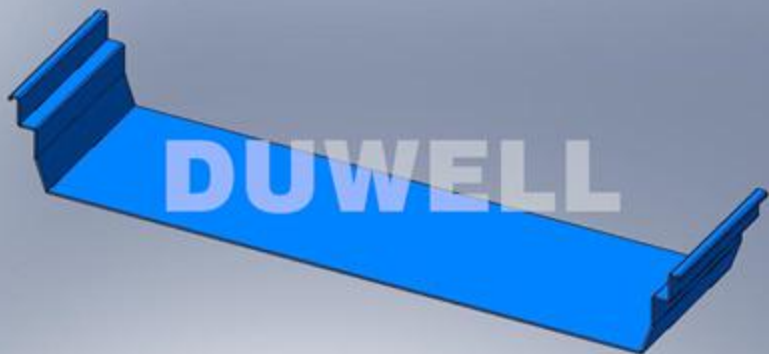

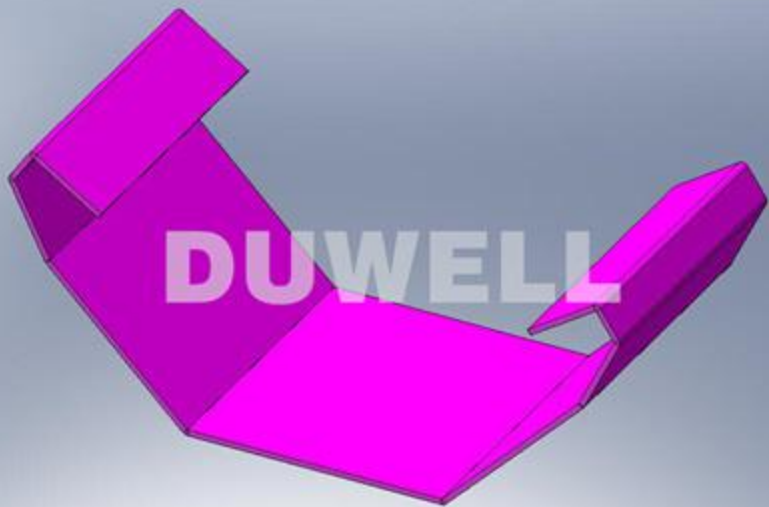

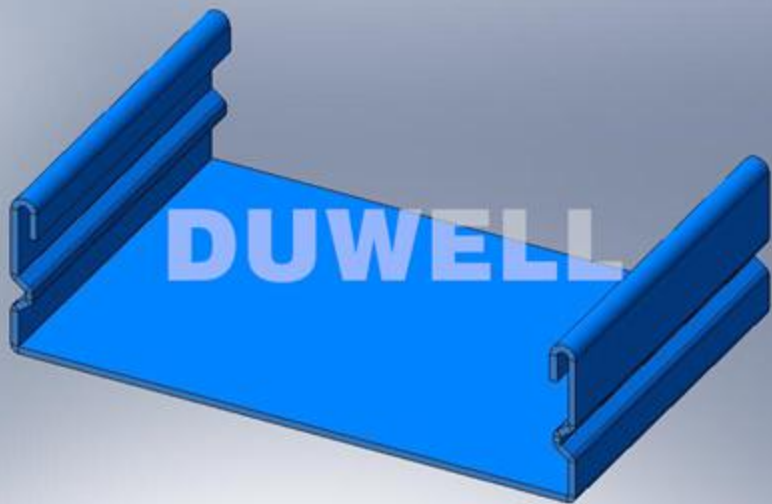



DUWELL

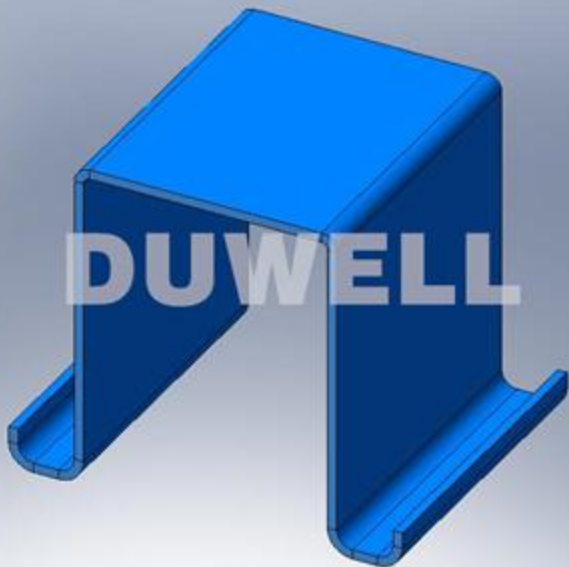



DUWELL

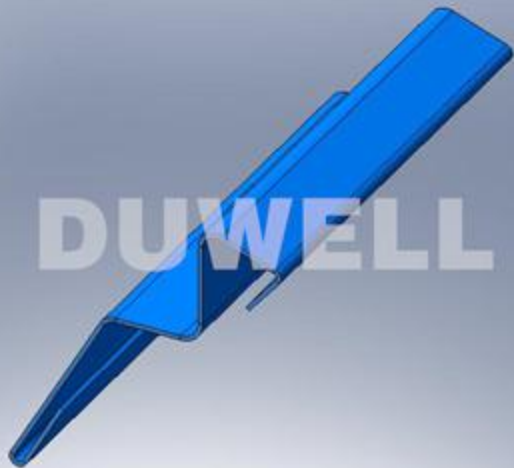

A 3D perspective rendering of a purple extruded profile, likely a window frame component. The profile has a complex shape with a wide top flange, a vertical section, and a bottom section with a sloped edge. The word "DUWELL" is overlaid in a semi-transparent white font across the center of the image.

DUWELL

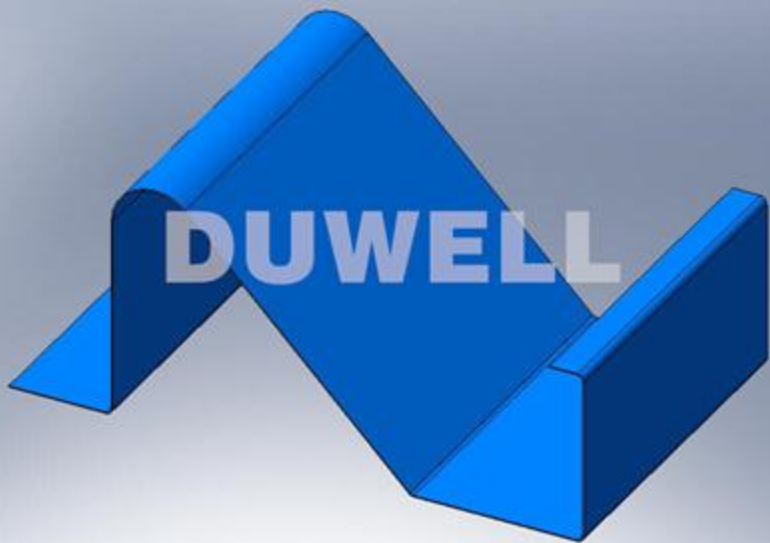



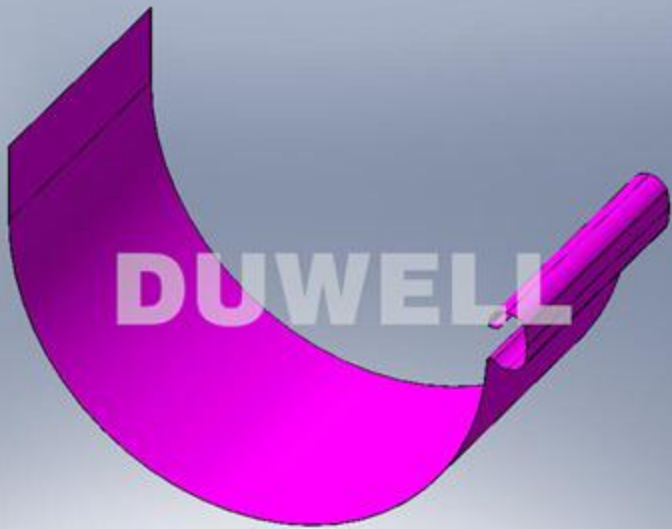

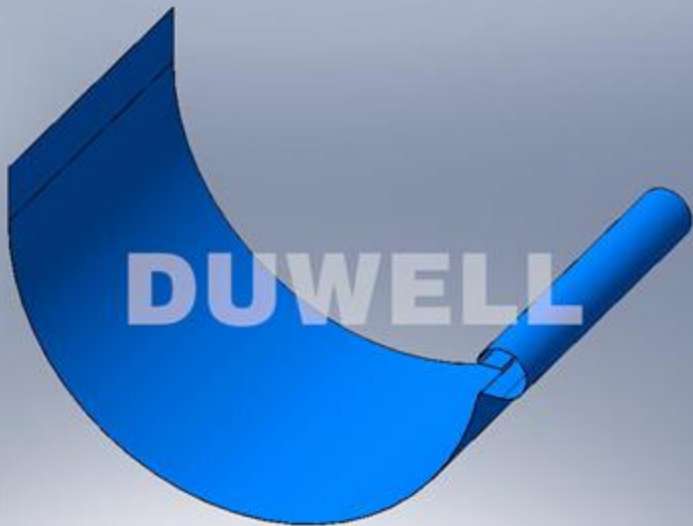

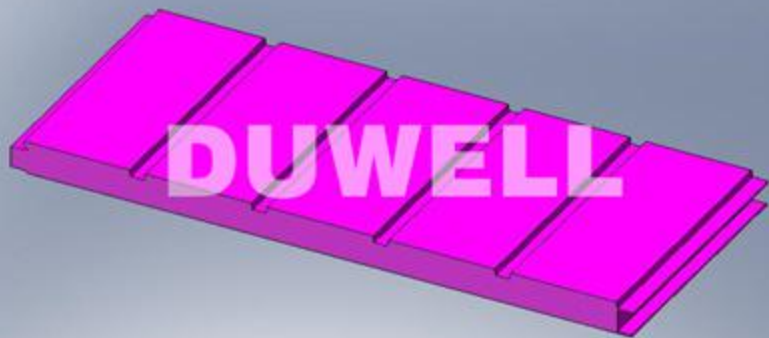

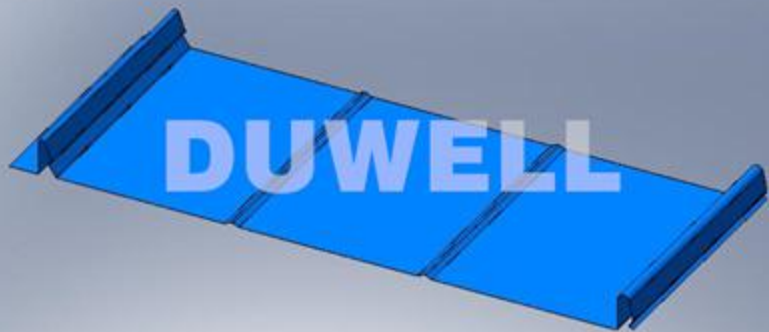

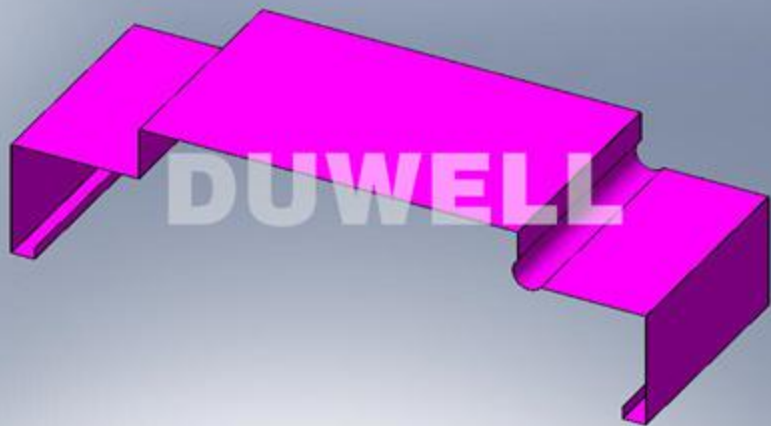

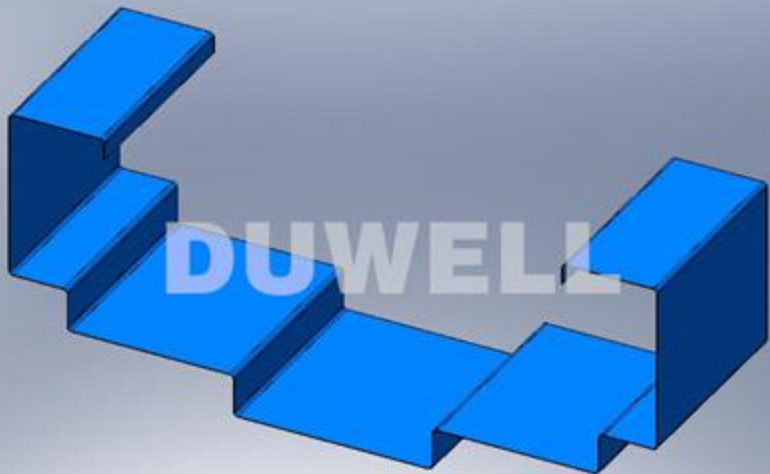

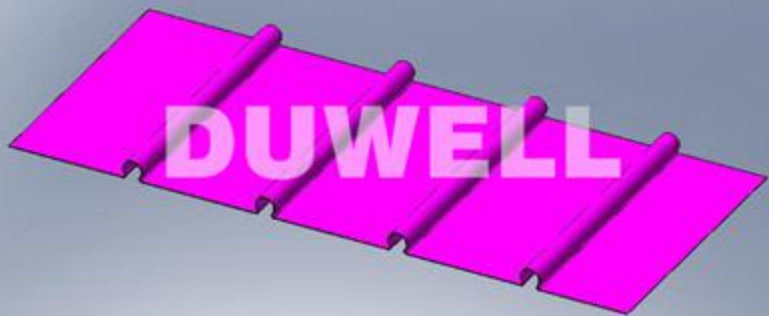

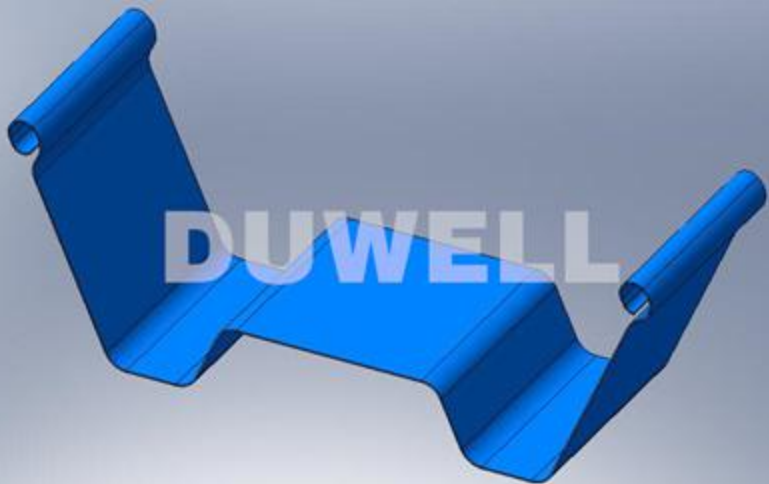

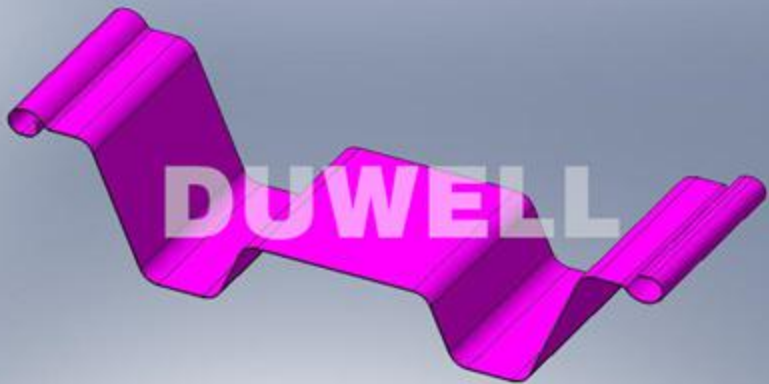

A vibrant blue ribbon graphic, curved and partially rolled at the top left and bottom right, set against a light blue gradient background. The word "DUWELL" is printed in bold, white, sans-serif capital letters across the center of the ribbon.

DUWELL

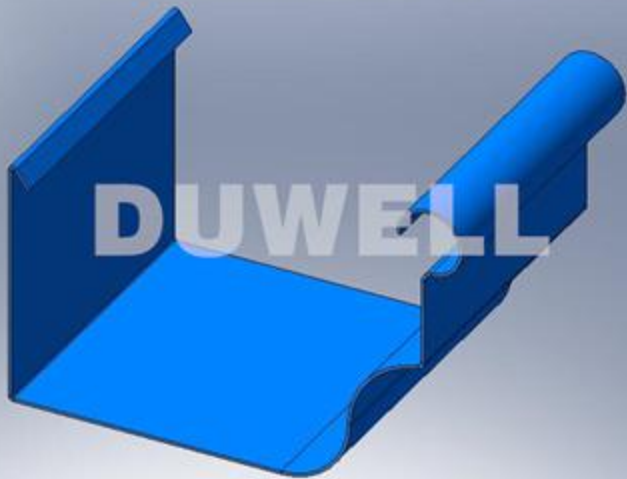

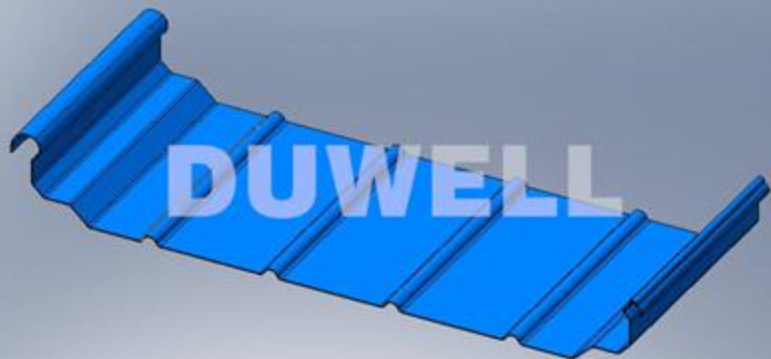

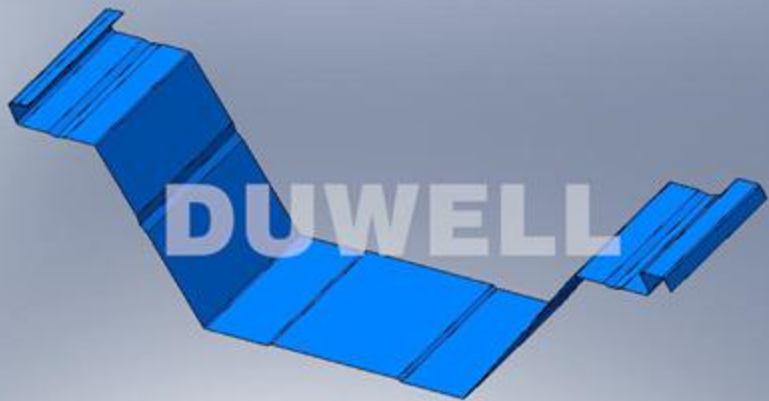

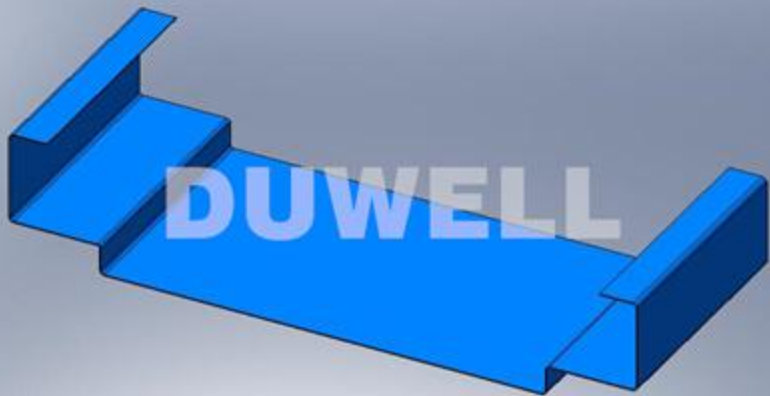

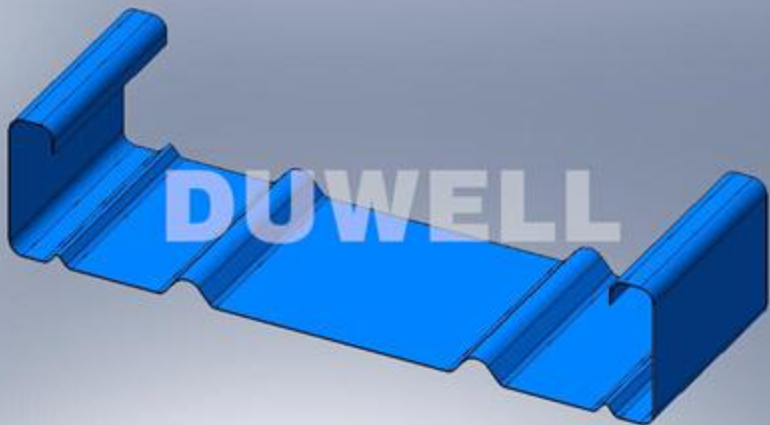

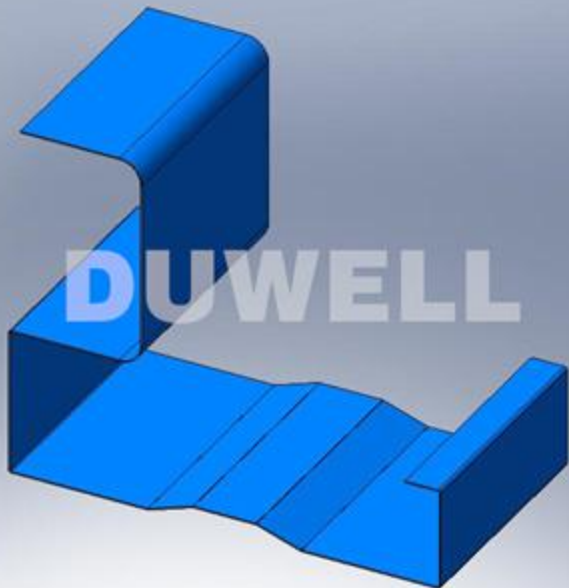

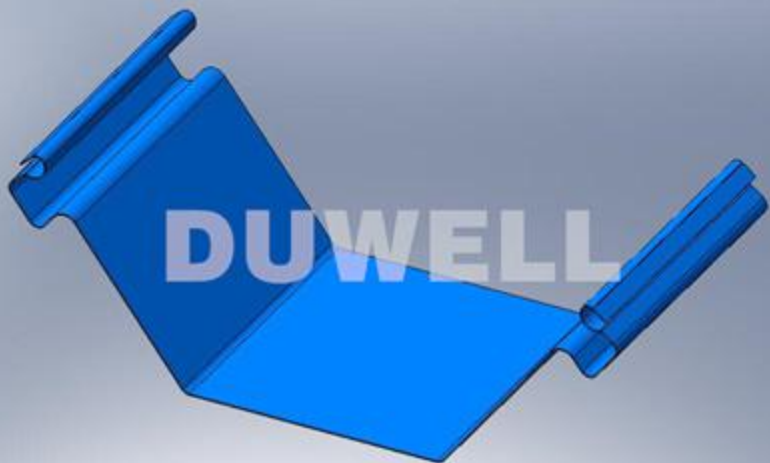

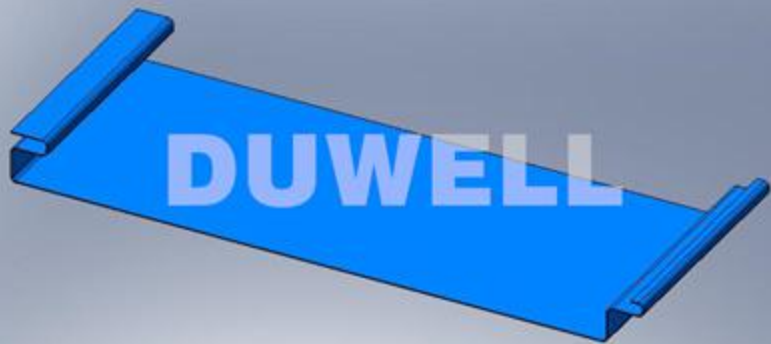

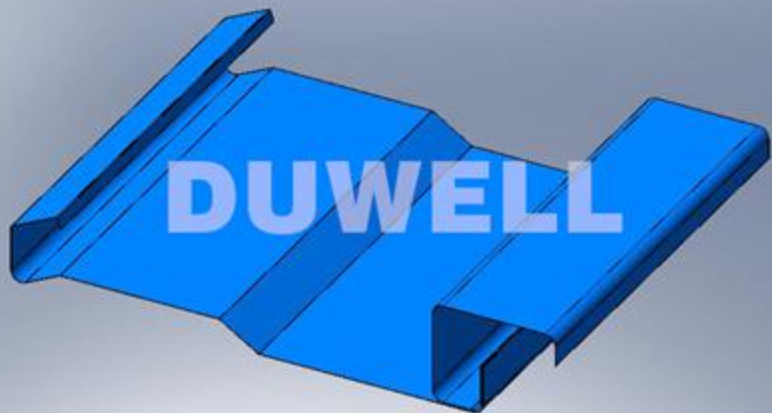

DUWELL

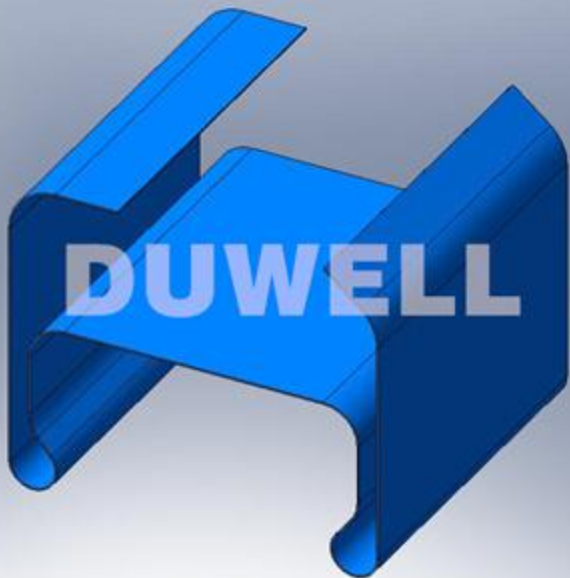



DUWELL

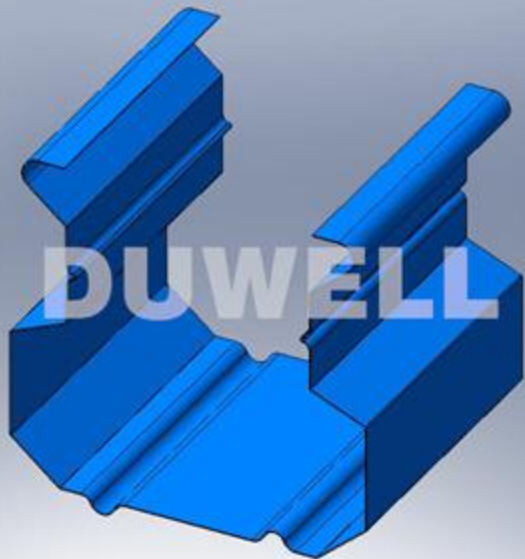

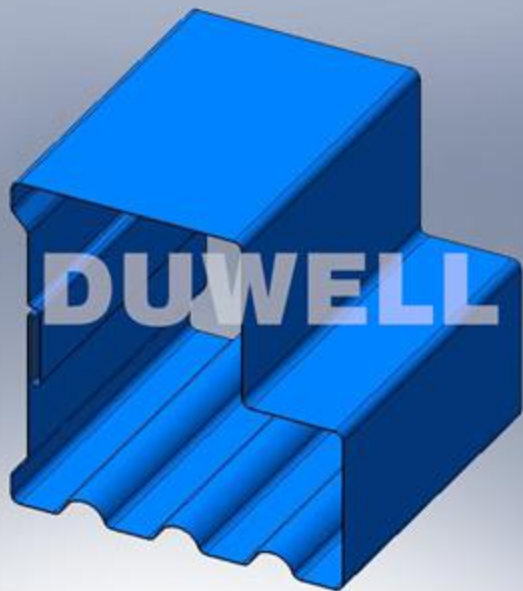

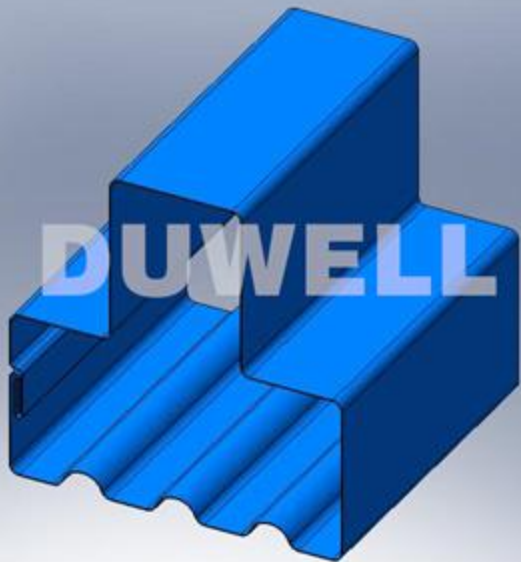

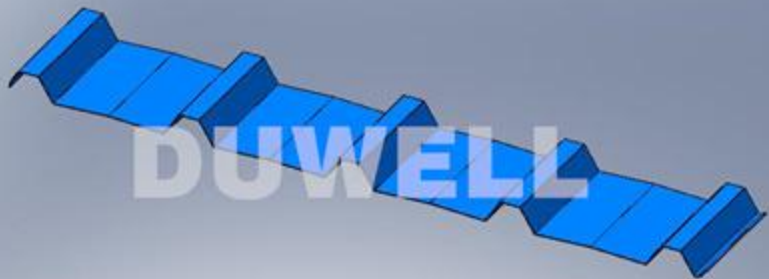

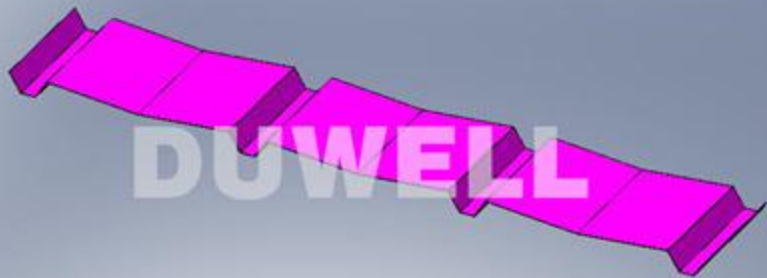





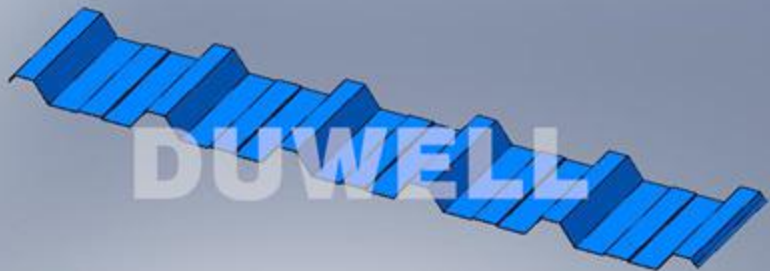

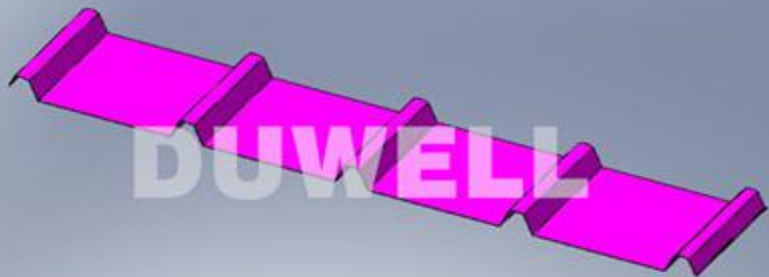

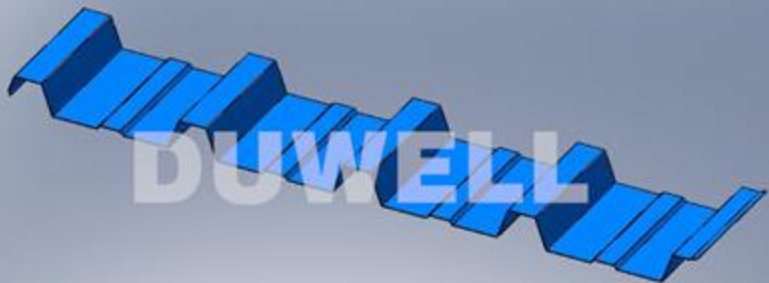

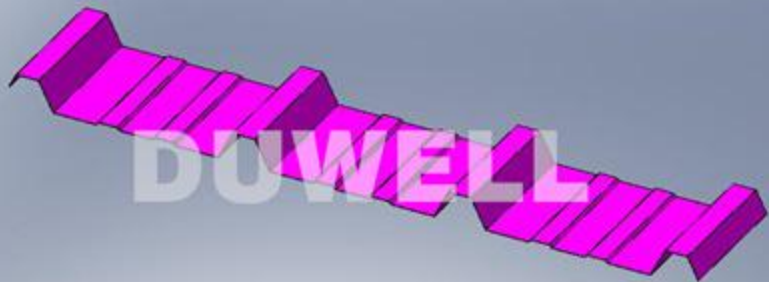





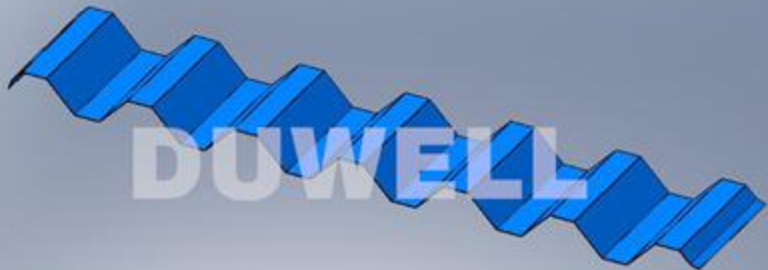

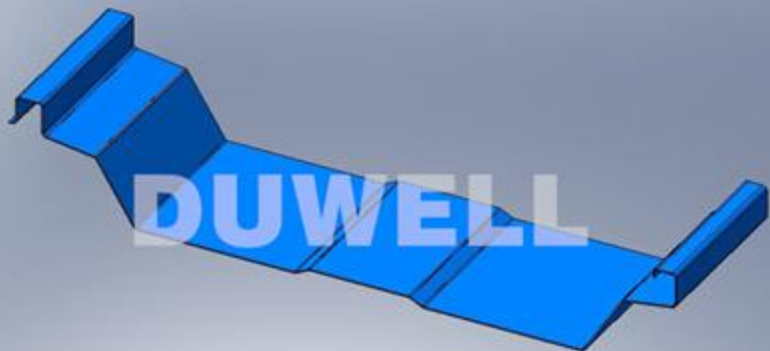

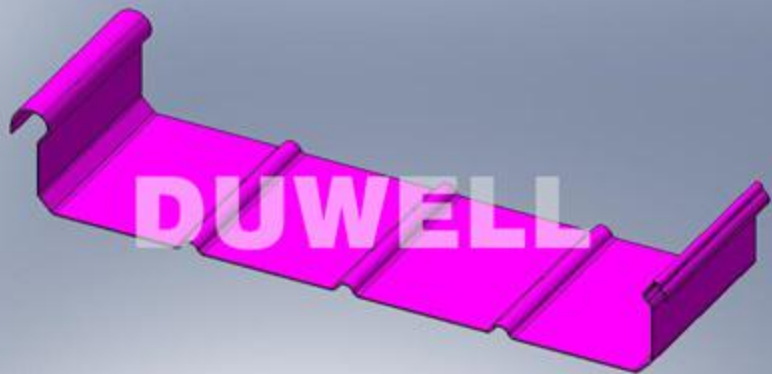

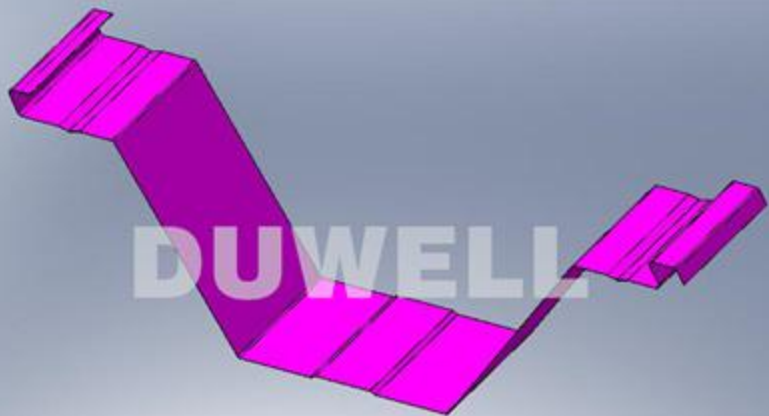

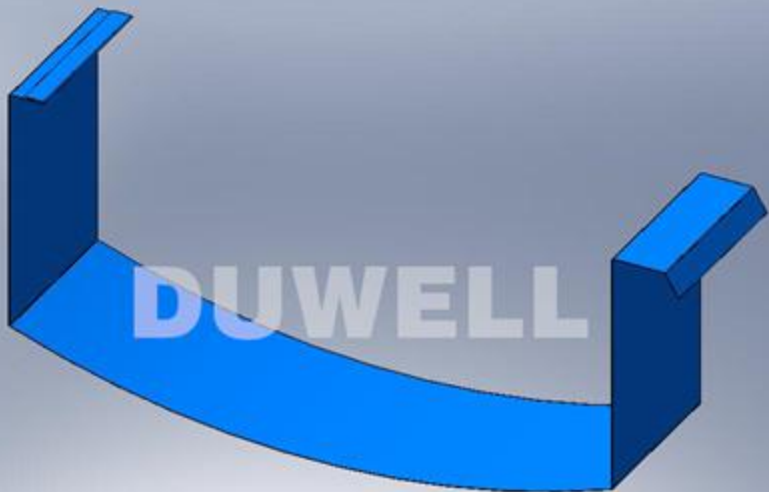

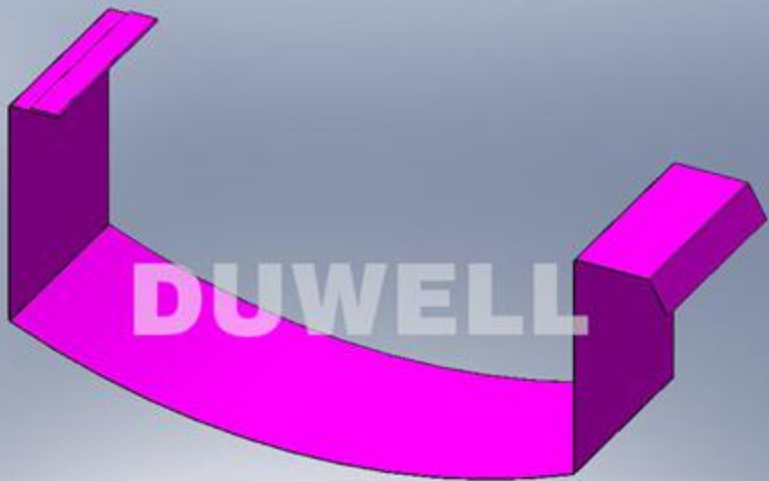

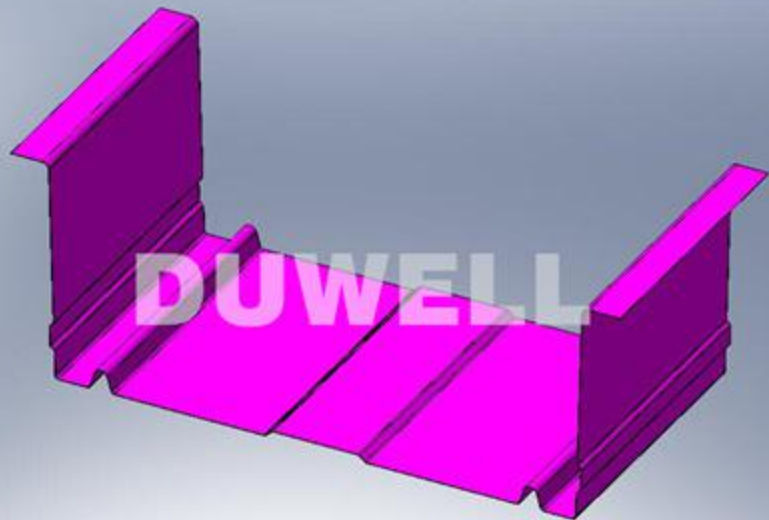

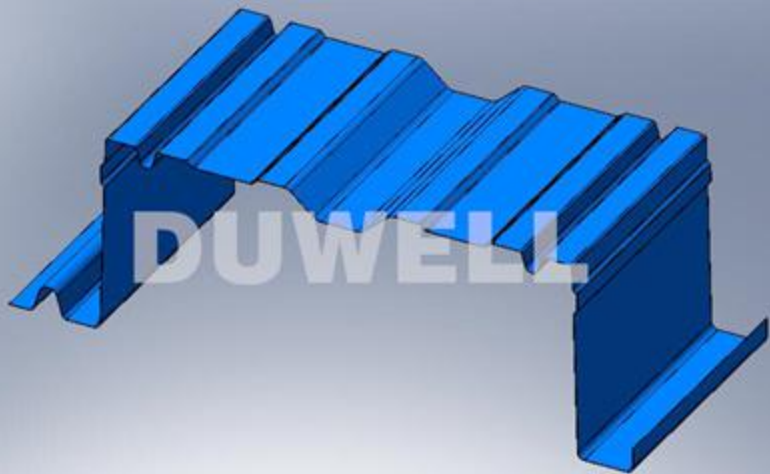

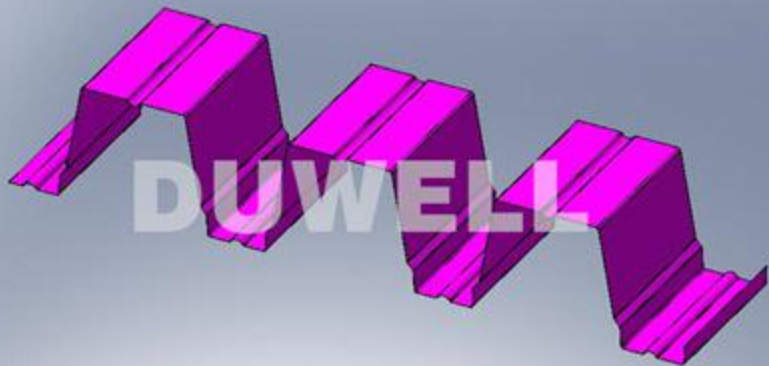

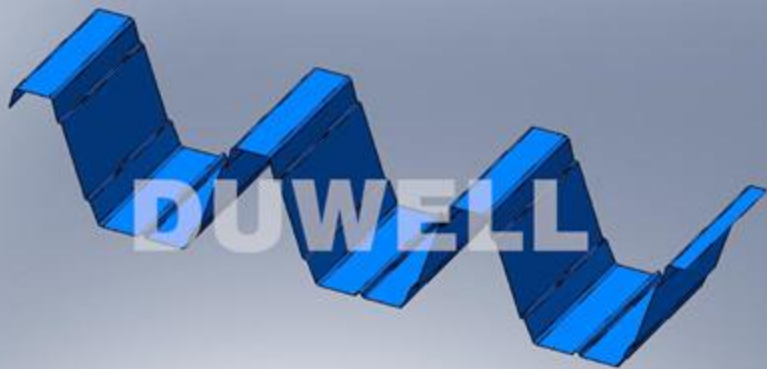

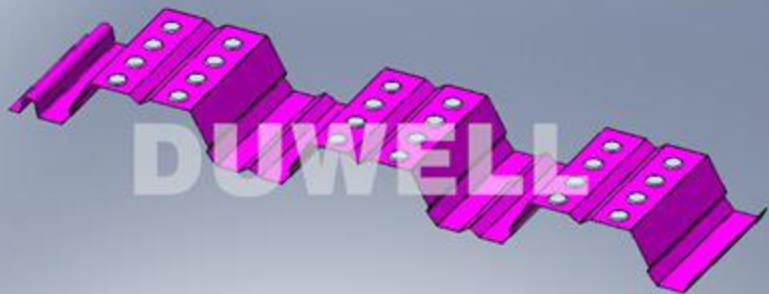

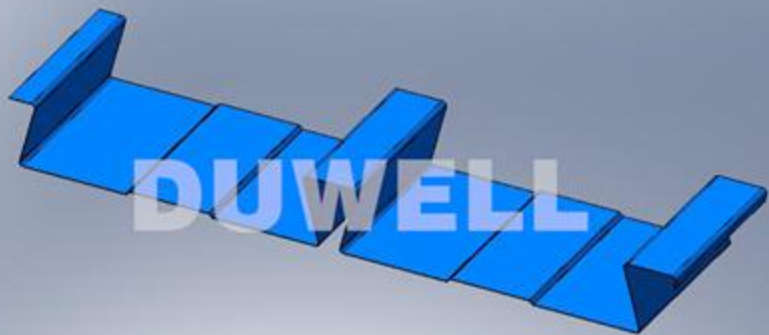





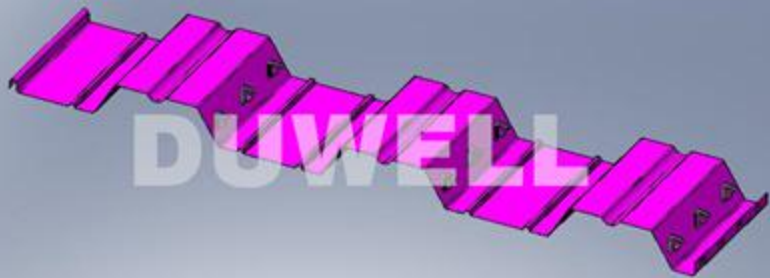

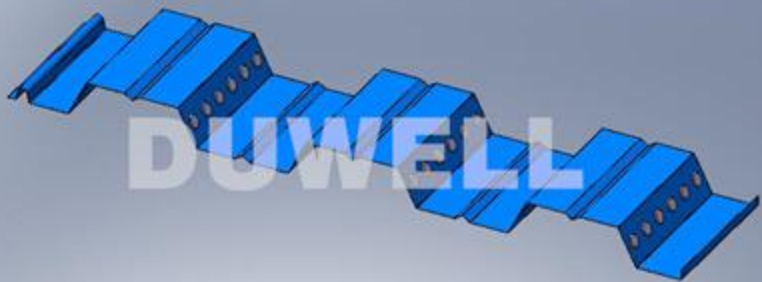

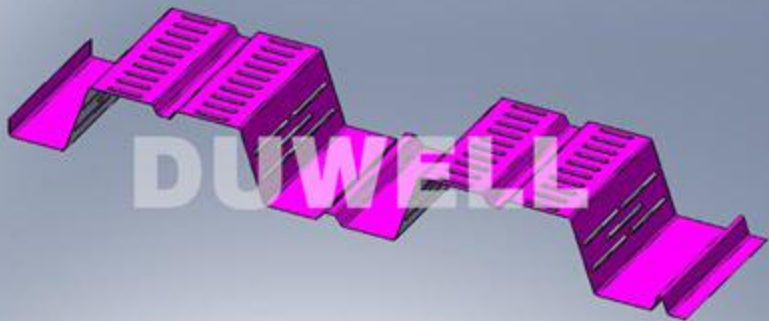

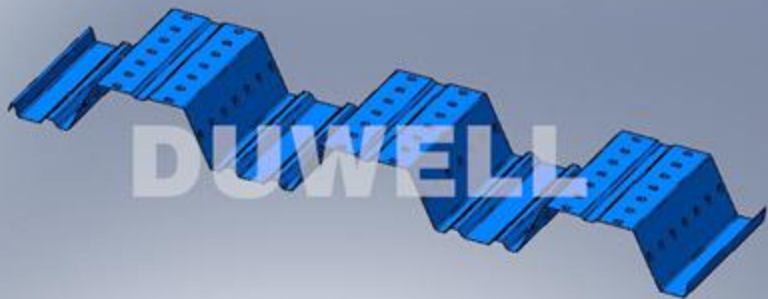

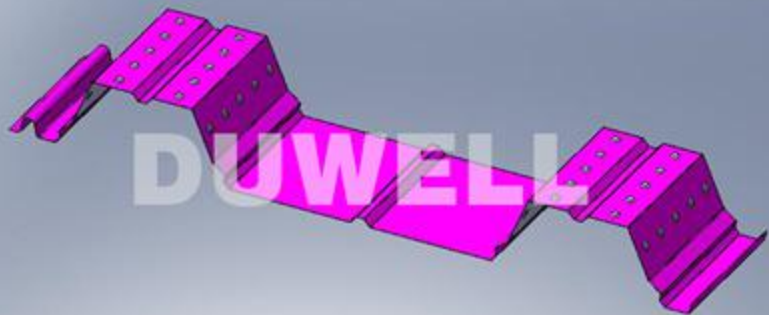

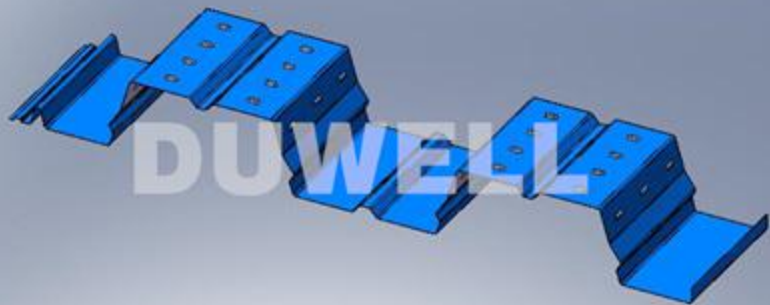





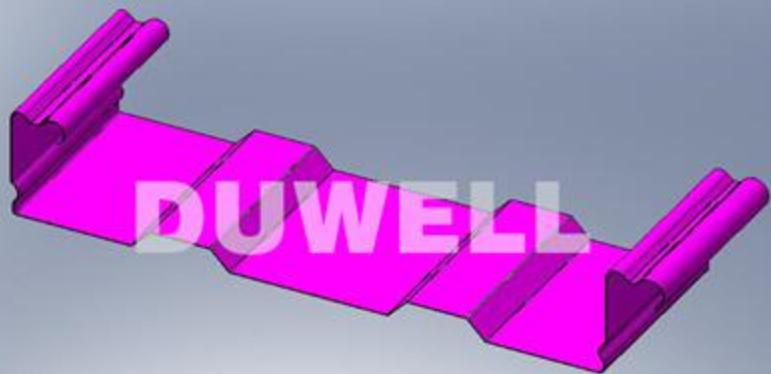

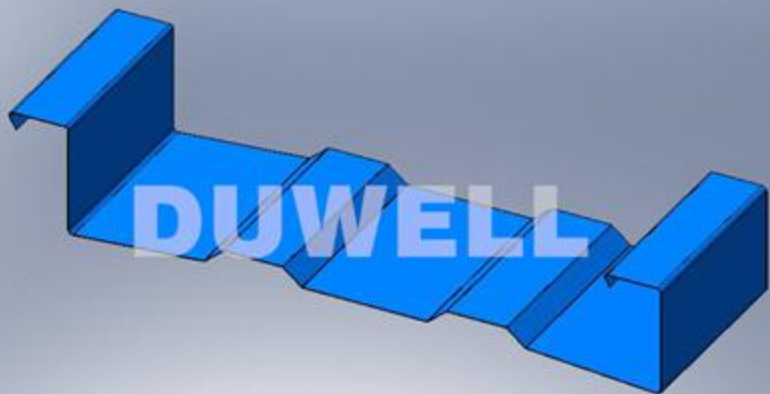

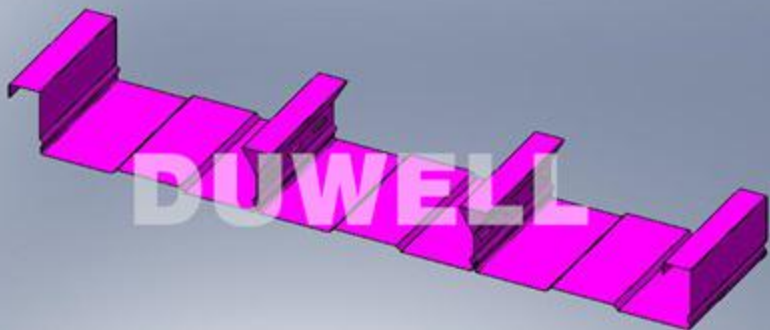

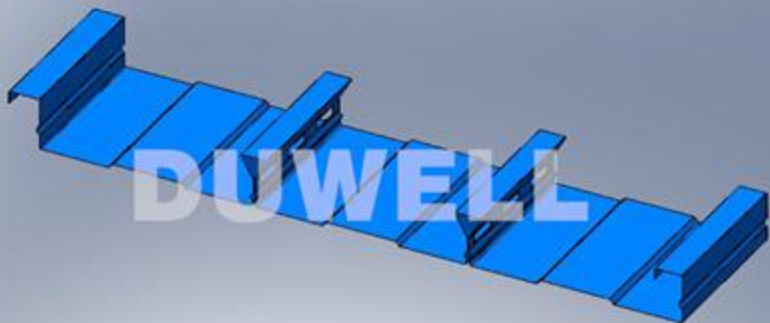

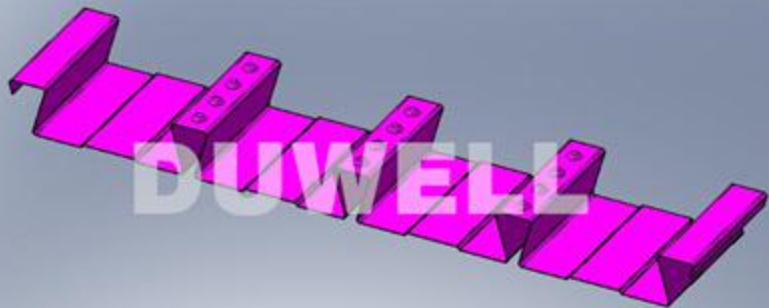

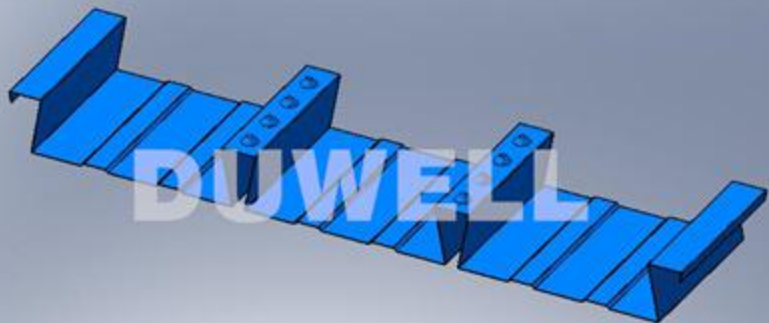

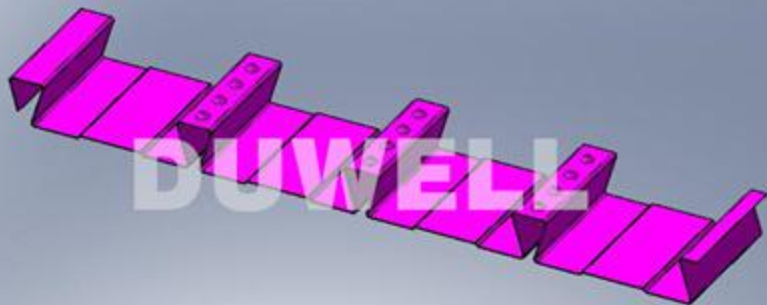

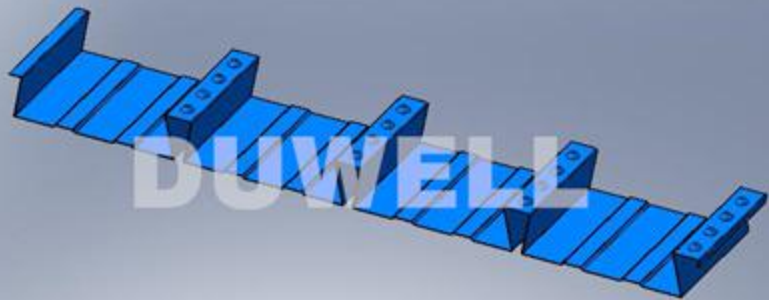

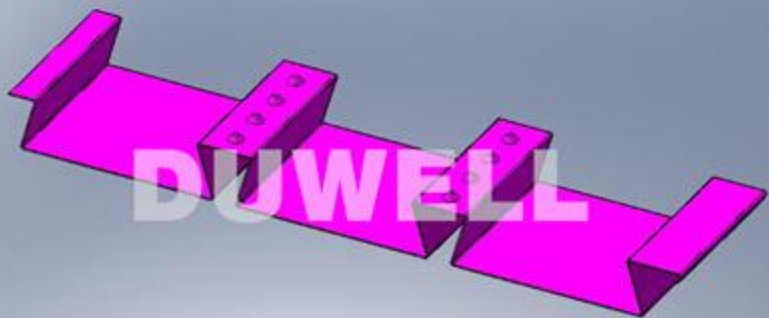

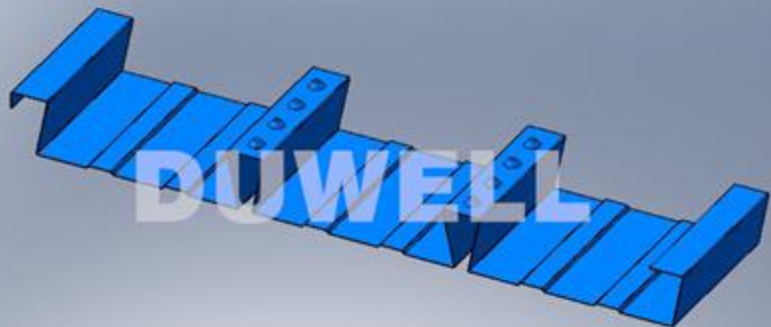

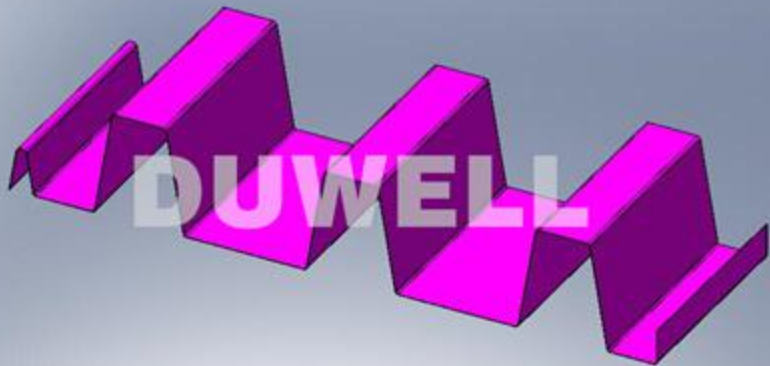

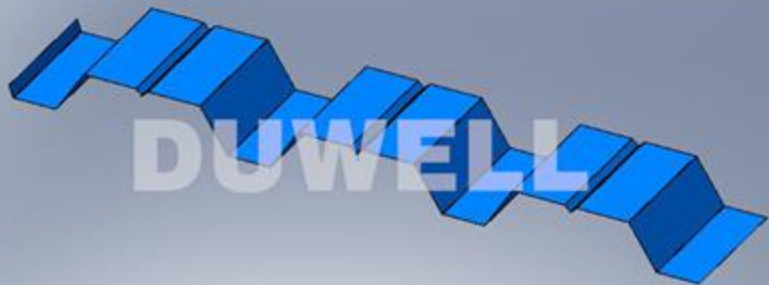



DUWELL



DUWELL



DUWELL

DUWELL

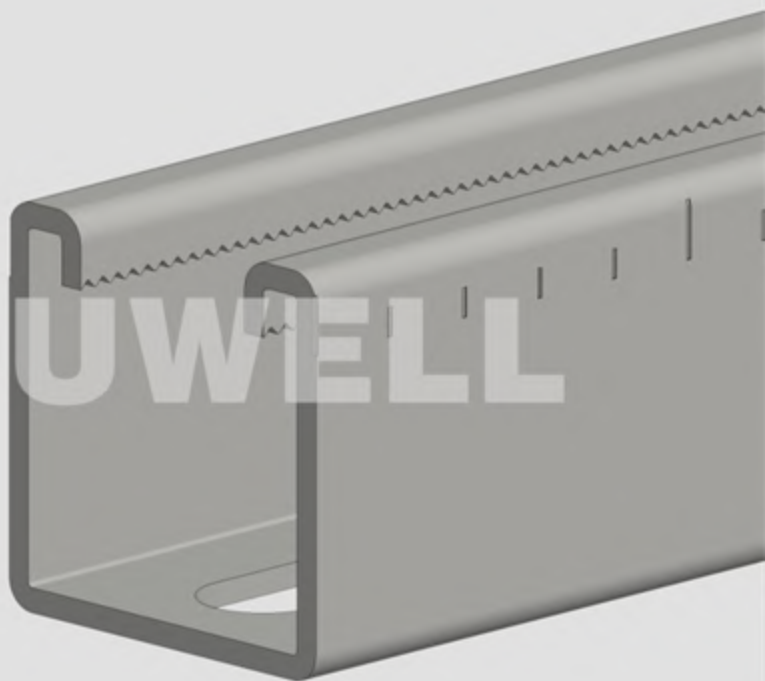



DUWELL

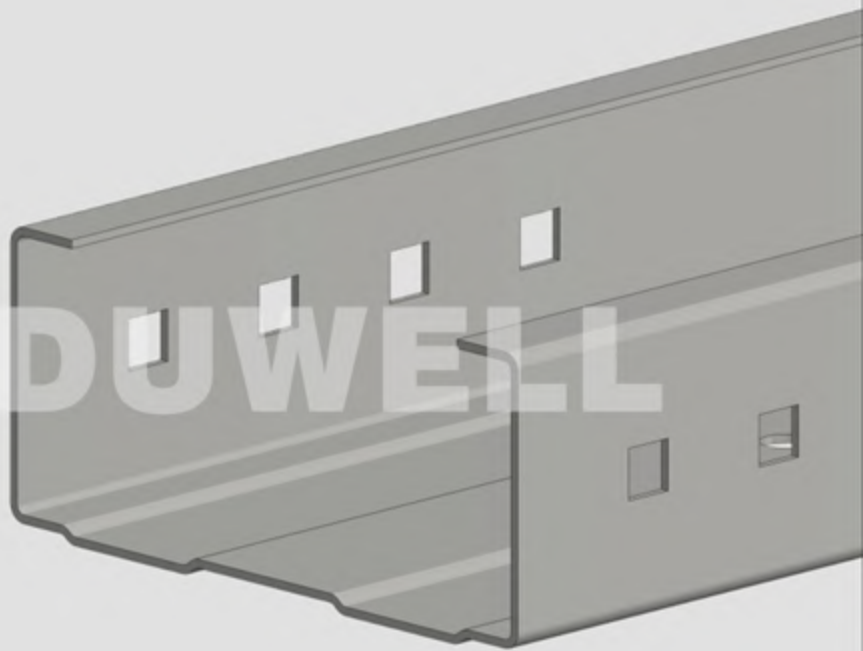

DUWELL

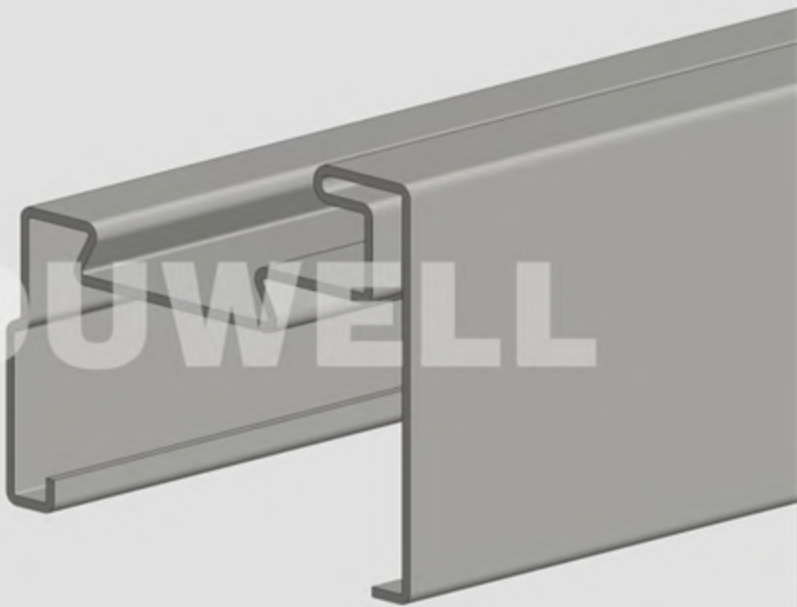

DUWELL

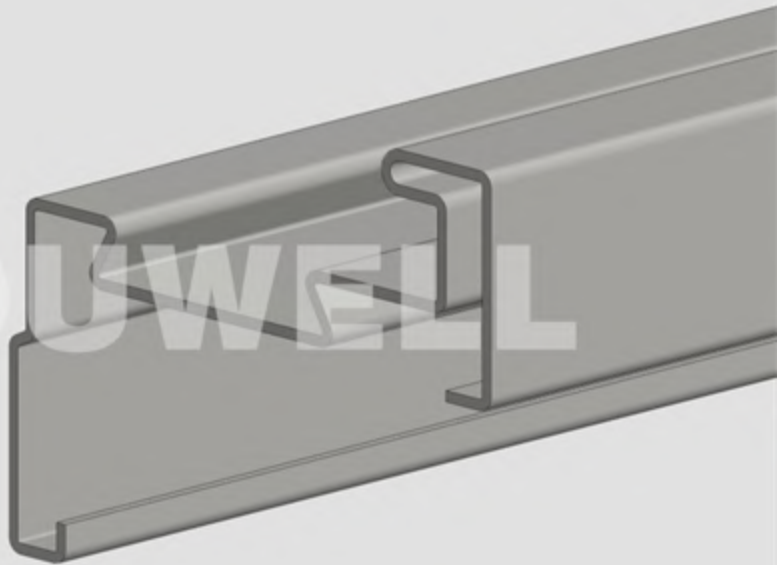



A 3D perspective rendering of a metal rail assembly, likely for a sliding door or window. The assembly consists of two main horizontal rails. The upper rail has a T-shaped profile with a circular hole on its top surface. The lower rail has a similar profile with a circular hole on its bottom surface. Both rails feature several rectangular cutouts along their length. A central component, possibly a roller or a pin, is visible between the two rails. The entire assembly is rendered in a light gray color. A large, semi-transparent watermark with the word "DUNWELL" is overlaid across the center of the image.

DUNWELL



DUWELL



DUWELL

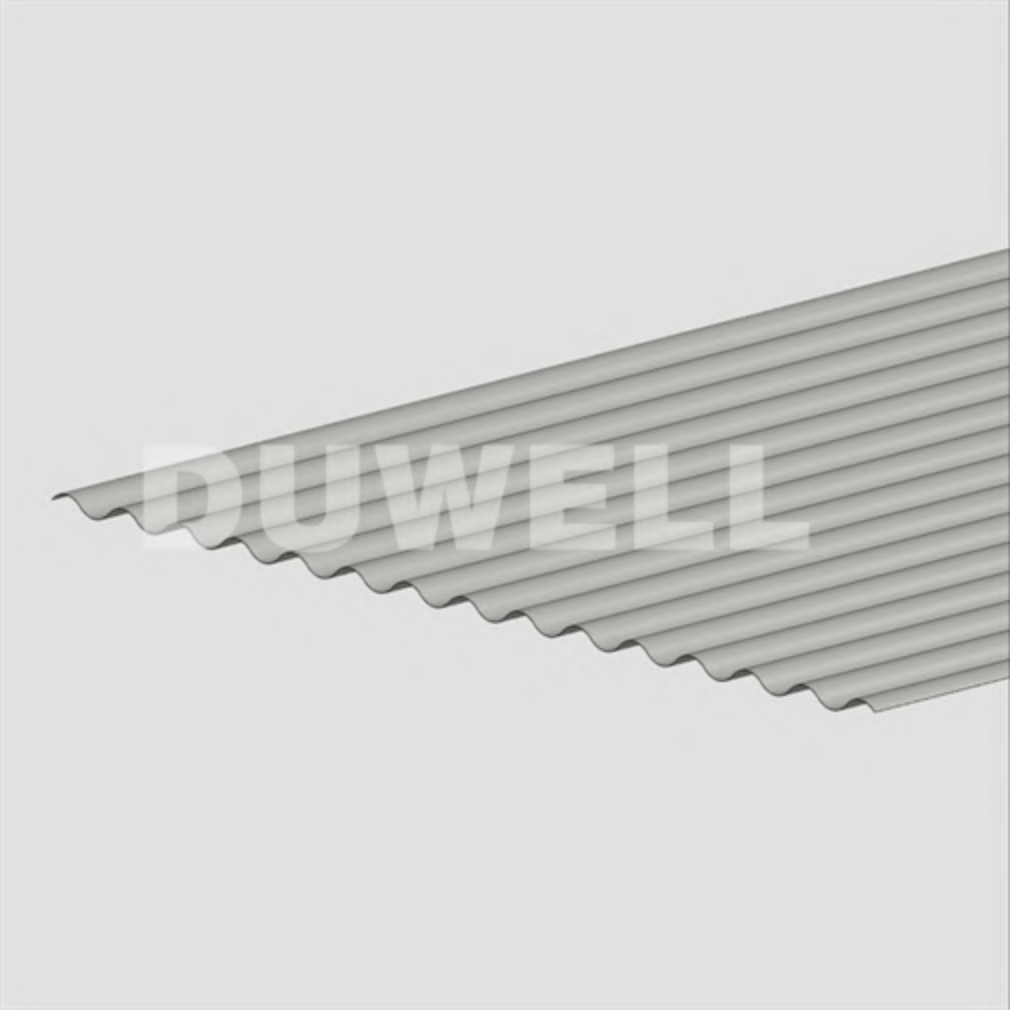

DUWELL

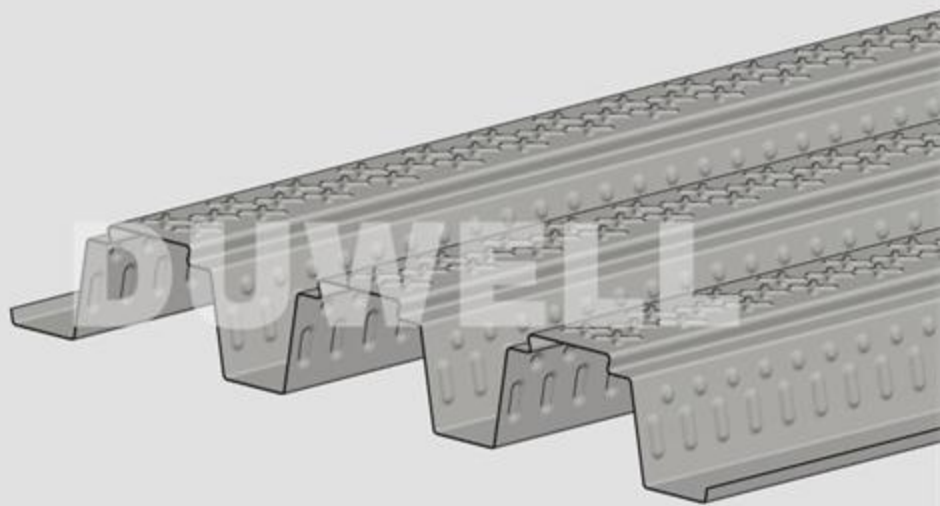

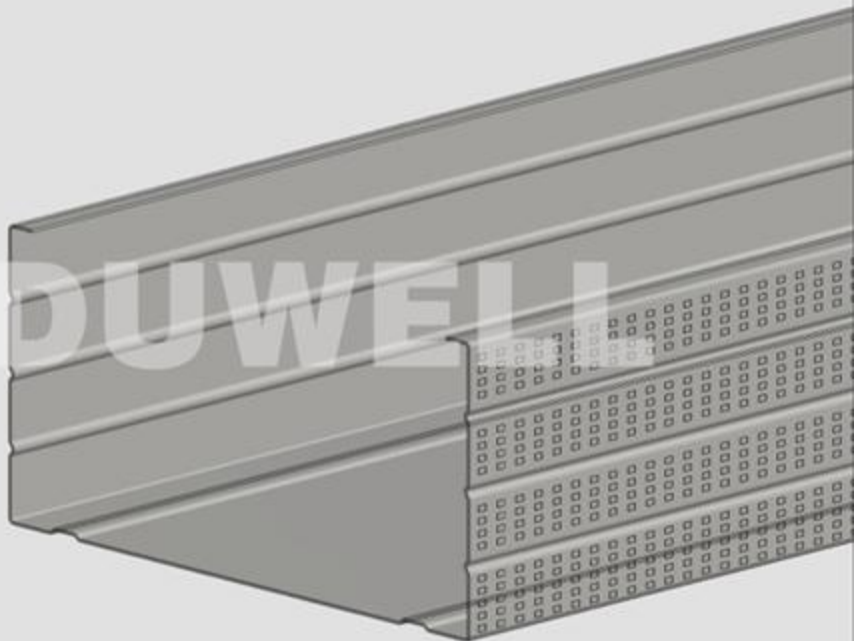

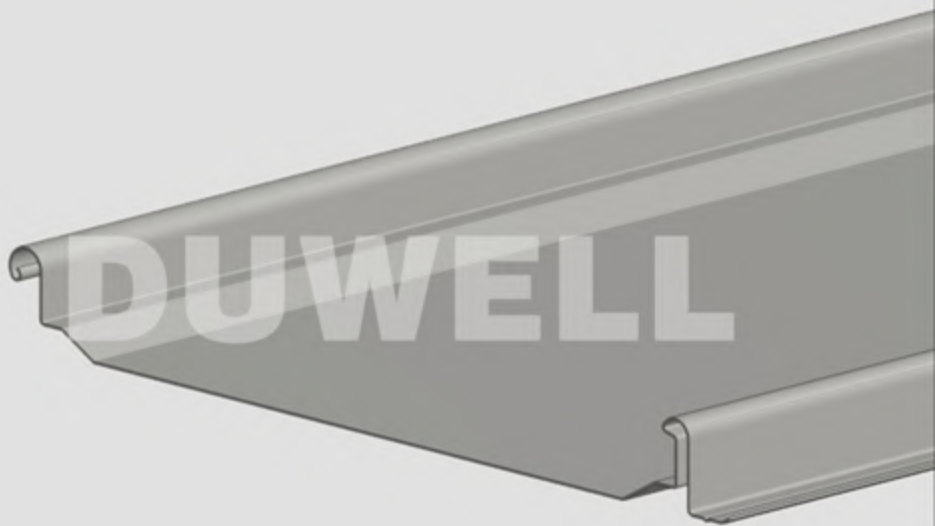

DUWELL

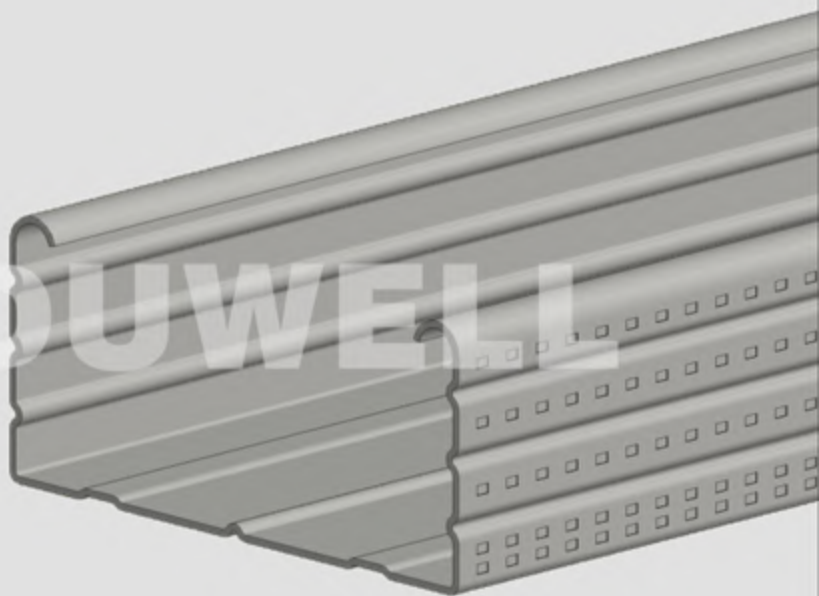



DUWELL

DUVV ELL

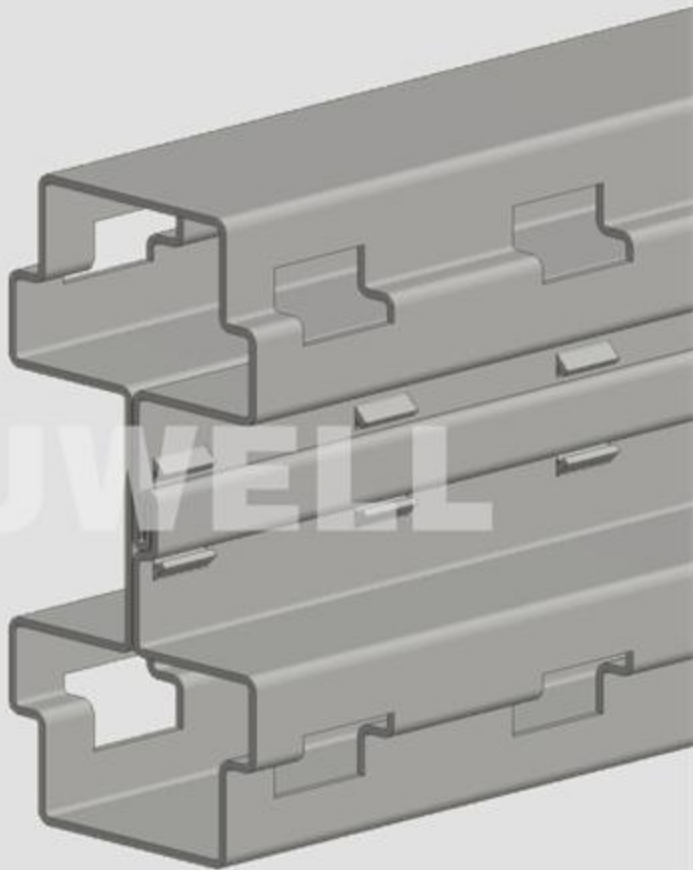

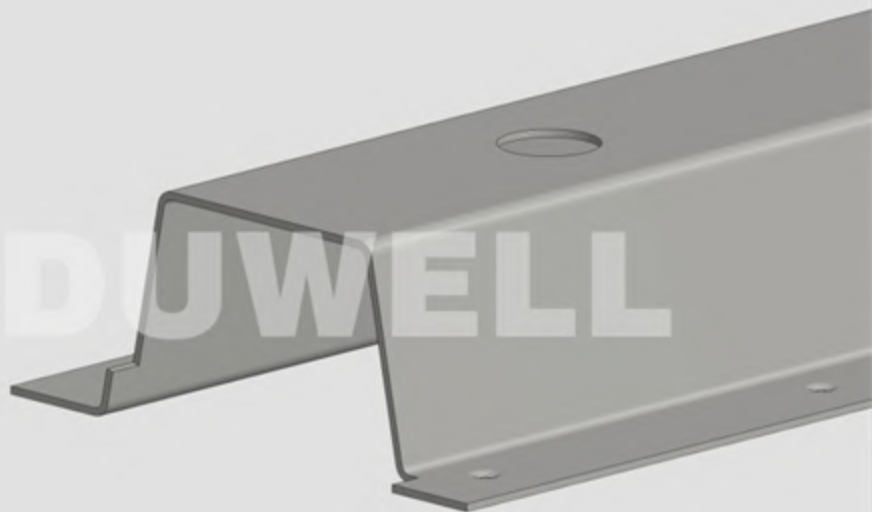

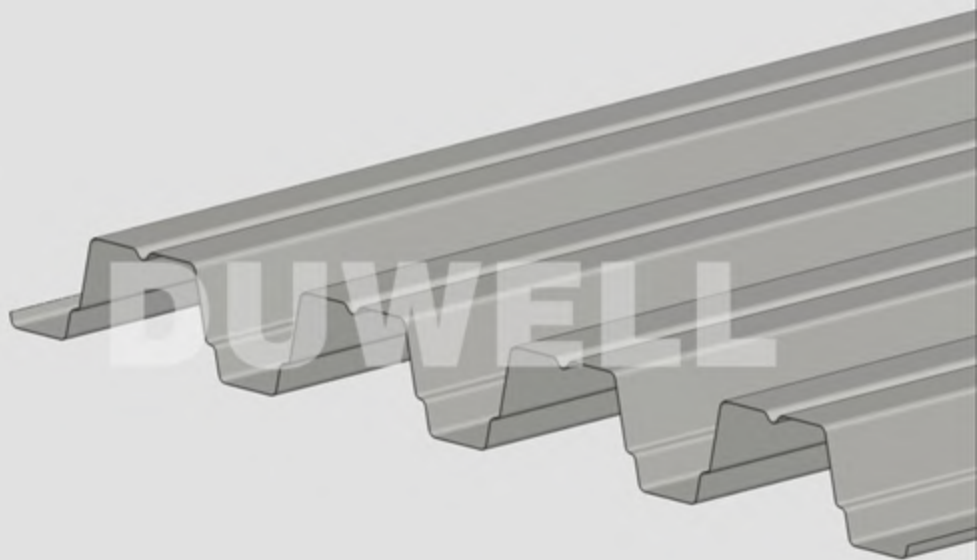



DUWELL

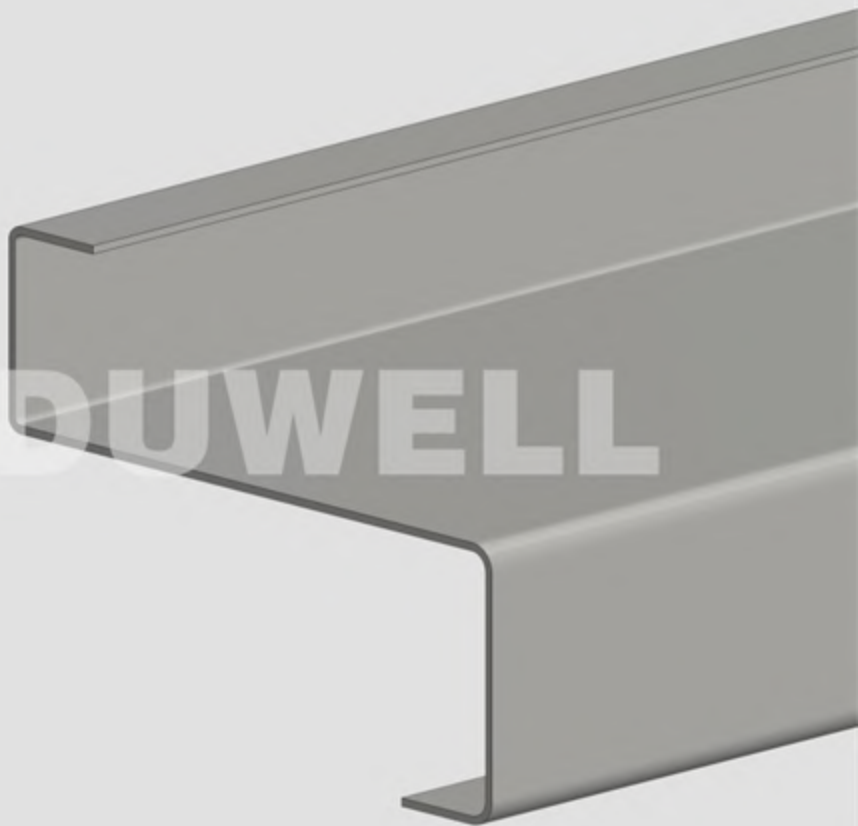



DUWELL

DUWELL

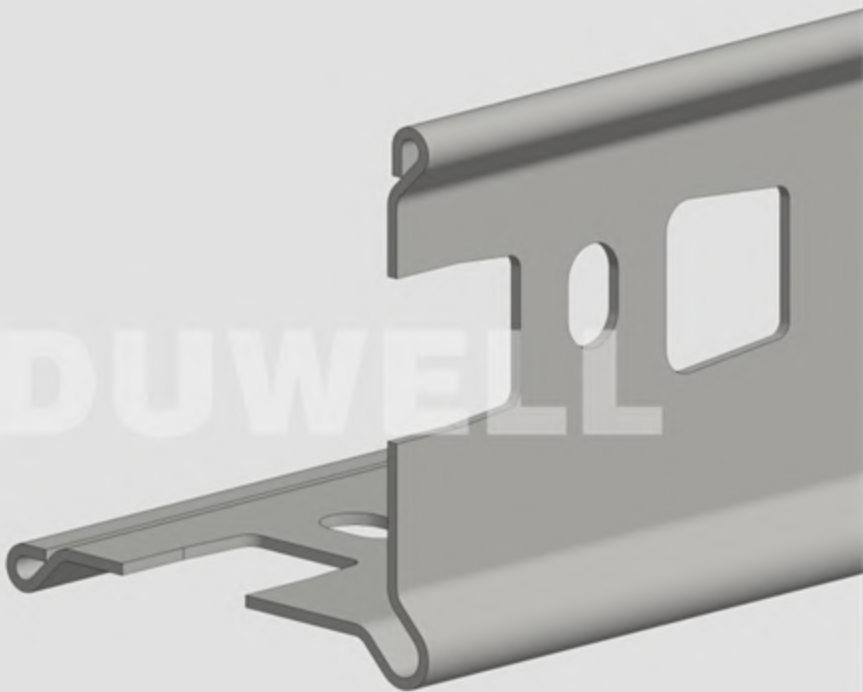



DUWELL



DUWELL

DUWELL

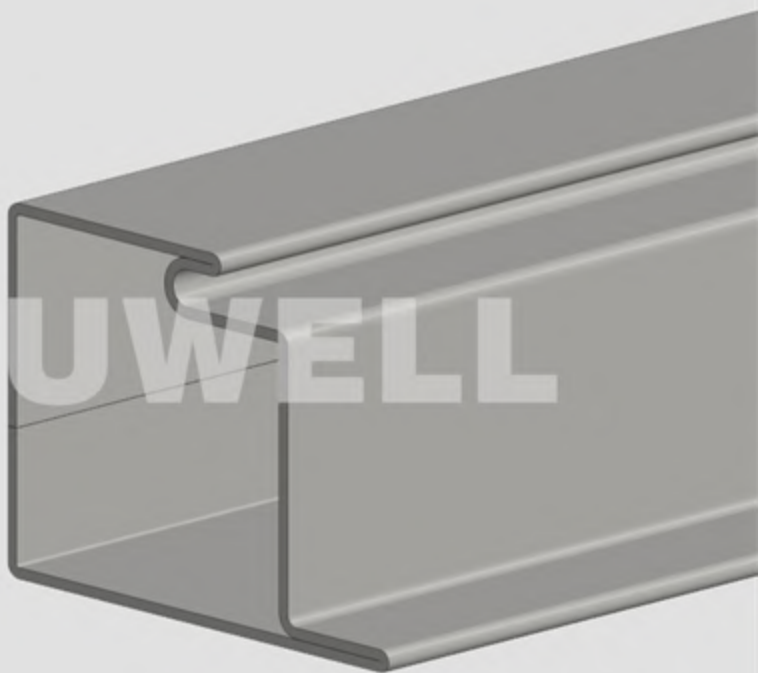



DUWELL



DUWELL

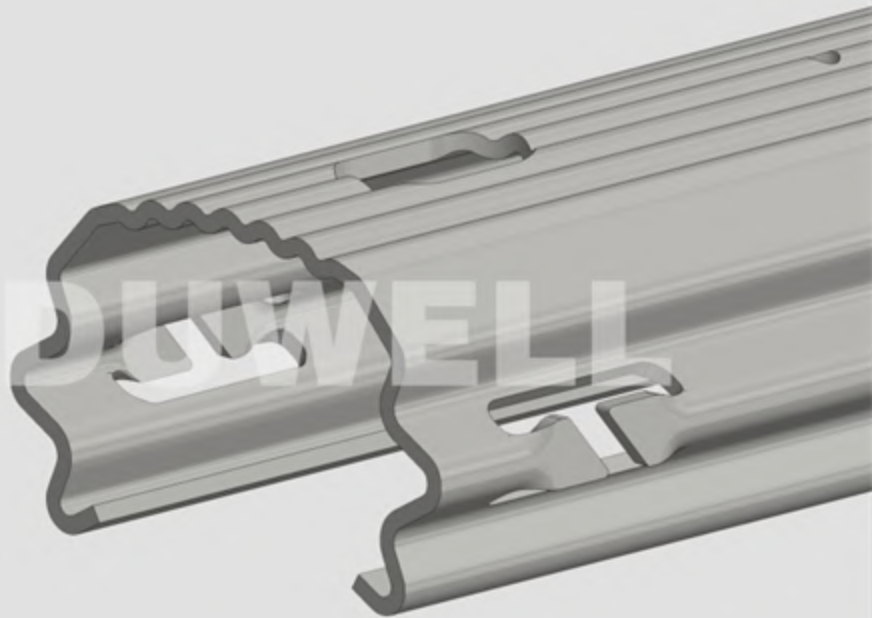



DUWELL

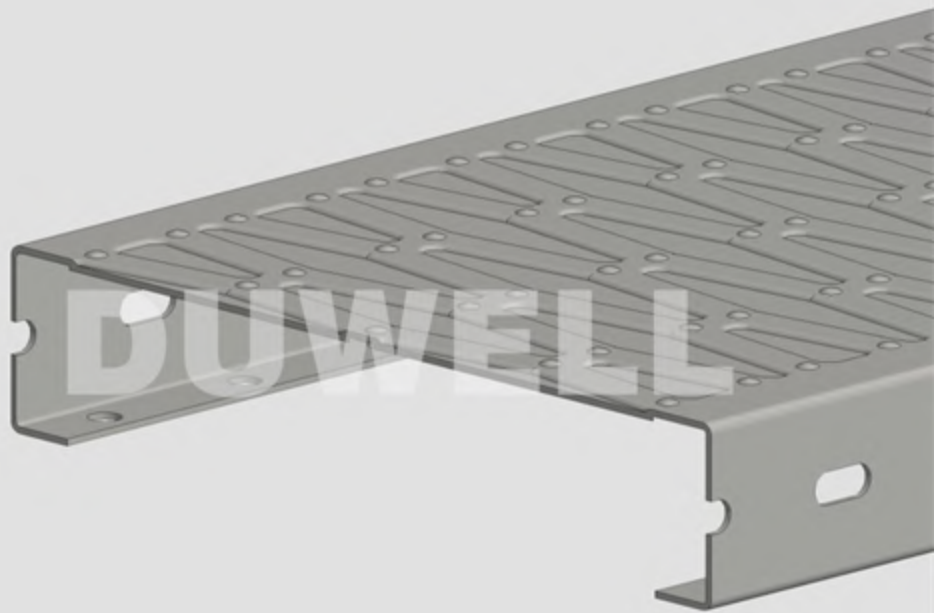



DUWELL

The image shows a close-up, perspective view of a grey metal channel. The channel has a C-shaped cross-section with a curved bottom flange. Along the top and bottom flanges, there are several circular pre-drilled holes. The metal has a smooth, slightly reflective surface. A large, semi-transparent watermark with the word "DUWELL" is overlaid across the center of the image.